

 APOLLO DISPLAY
TECHNOLOGIES



 DISTEC



 DISPLAY
TECHNOLOGY



Datasheet

Distec

PrismaMediaECO-II

All-In-One RGB/ HDMI/DP Converter Board For VGA – WUXGA Panels

PR-01-220	PrismaMediaECO-II-00-12RHDAU
PR-01-221	PrismaMediaECO-II-01-12RHD00
PR-01-222	PrismaMediaECO-II-02-24RHDAU
PR-01-224	PrismaMediaECO-II-03-24RHD00

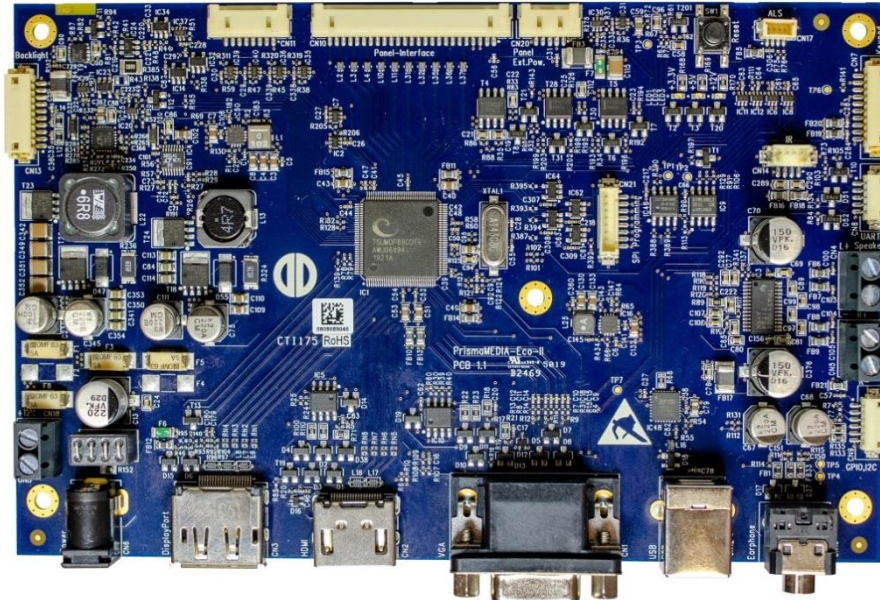

Version 1.1.0

08.12.2020

The information contained in this document has been carefully researched and is, to the best of our knowledge, accurate. However, we assume no liability for any product failures or damages, immediate or consequential, resulting from the use of the information provided herein. Our products are not intended for use in systems in which failures of product could result in personal injury. All trademarks mentioned herein are property of their respective owners. All specifications are subject to change without notice.

Table of Contents

1	REVISION HISTORY	4
2	OVERVIEW	5
3	GENERAL FEATURES	5
3.1	HARDWARE FEATURES	6
4	POWER CONCEPT	7
5	OSD MENU AND USER CONTROLS	8
5.1	OSD CONTROL THROUGH EXTERNAL KEYPAD	8
6	ON- SCREEN-MENU	10
6.1	BRIGHTNESS/CONTRAST TAB	10
6.2	COLOR SETTINGS TAB	10
6.3	INPUT SOURCE TAB	11
6.4	DISPLAY SETTINGS TAB	12
6.5	OTHER SETTINGS TAB	13
6.6	INFORMATION TAB	14
6.7	AUTO ADJUST TAB	14
6.8	INPUT SOURCE WINDOW	15
6.9	VOLUME CONTROL	15
6.10	BRIGHTNESS CONTROL	15
7	SUPPORTED INPUT MODES	16
7.1	VGA	16
7.2	HDMI – GRAPHICS	16
7.3	HDMI – VIDEO	17
7.4	DISPLAYPORT	17
8	AUDIO SUPPORT	18
8.1	AUDIO INPUT	18
8.2	AUDIO OUTPUT	18
9	ABSOLUTE MAXIMUM RATINGS	19
10	ELECTRICAL CHARACTERISTICS	19
10.1	MAXIMAL ALLOWED POWER CONSUMPTION FOR TFT PANELS (V_{SVCC})	20
10.2	MAXIMAL ALLOWED POWER CONSUMPTION FOR BACKLIGHT INVERTER (V_{BKLT})	20
11	MECHANICAL SPECIFICATION	20
11.1	MECHANICAL DRAWING	21
12	CONNECTOR OVERVIEW	22
12.1	INPUT CONNECTORS	23
12.2	OUTPUT CONNECTORS	26
12.3	I/O CONNECTOR	27
13	SUPPORTED PANELS AND BACKLIGHTS (INVERTER/CONVERTER)	28
14	HARDWARE INFORMATION	28

1 Revision History

Date	Rev.No.	Description	Page
12.10.2020	1.0	Initial version	All
08.12.2020	1.1.0	Deleted CN13 from Inputs and corrected name of CN9	27, 25

2 Overview

The PrismaMediaEco-II is a powerful graphics processing board, providing high-quality images for TFT panels. This converter supports 6/8-bit LVDS panels up to WUXGA (1920 x 1200) and can be used in a variety of systems.

3 General Features

- 24V or 12V main power input
- DP1.2a, HDMI 1.3 (compatible with HDMI 1.4) and DVI 1.0 compliant receiver
- Analog RGB/VGA input captures 1920 x 1200 @ 60Hz
- Analog RGB Sync On Green Capable
- Supports 18 and 24-bit color depths
- Supports VESA DDC/CI and Full Green Mode VESA DPMS support
- Support OSD Rotation 0, 90, 180, 270 degree
- DDC-Control on VGA, HDMI and Display Port
- USB (or serial) remote control capability (Remote OSD via PC)
- PWM or voltage controlled backlight intensity
- Four and Six-button external OSD - keypad interface and on-screen menus allow adjustments to the system
- Auto Brightness regulation in combination with a ambient light sensor
- Supports headphone drive (20mW@32Ω, 40mW@16Ω)
- RoHS
- Fully Customizable through the configuration software (MstarRover)

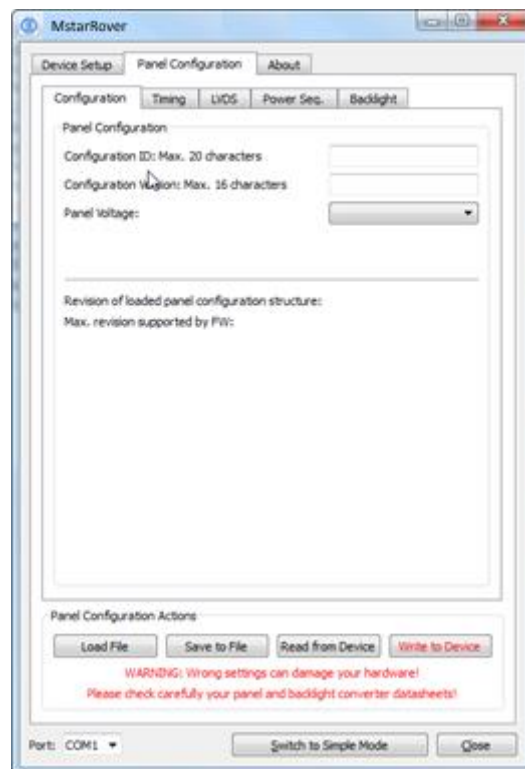

3.1 Hardware Features

Analog RGB Input

- Supports up to 1792x1344@60Hz or 1920x1200@60Hz or 1600x1200@60Hz standard modes
- Captures up to 205MHz

Ultra-Reliable HDMI 1.3 Receiver

- Single Link TMDS Rx for up to 12-bit 1080p
- Captures up to 225MHz
- Direct connect to all HDMI compliant TMDS transmitters
- No HDCP support

DisplayPort Receiver

- 10.8Gbps total bandwidth over 4 lanes
- No HDCP support

LVDS Interface

- Supports up to 8-bit LVDS WUXGA (1920x1200) panel interface
- Spread Spectrum output frequency for EMI suppression

Auto-Configuration / Auto-Detection

- Phase and image positioning
- Input format detection

On Screen Display

- Supports OSD rotation degree 0°, 90°, 180°, 270°
- Support 2/4/8/16 multi-color font

Output Format

- Single/double wide LVDS up to WUXGA 60Hz output
- Support for 8 or 6-bit panels (with high-quality dithering)

Audio Output

- 5W/Ch (8Ω) audio output (L/R) for HDMI/DP embedded audio

USB Interface

- USB 2.0 Full Speed compatible

4 Power Concept

PrismaMediaEco-II Power Concept

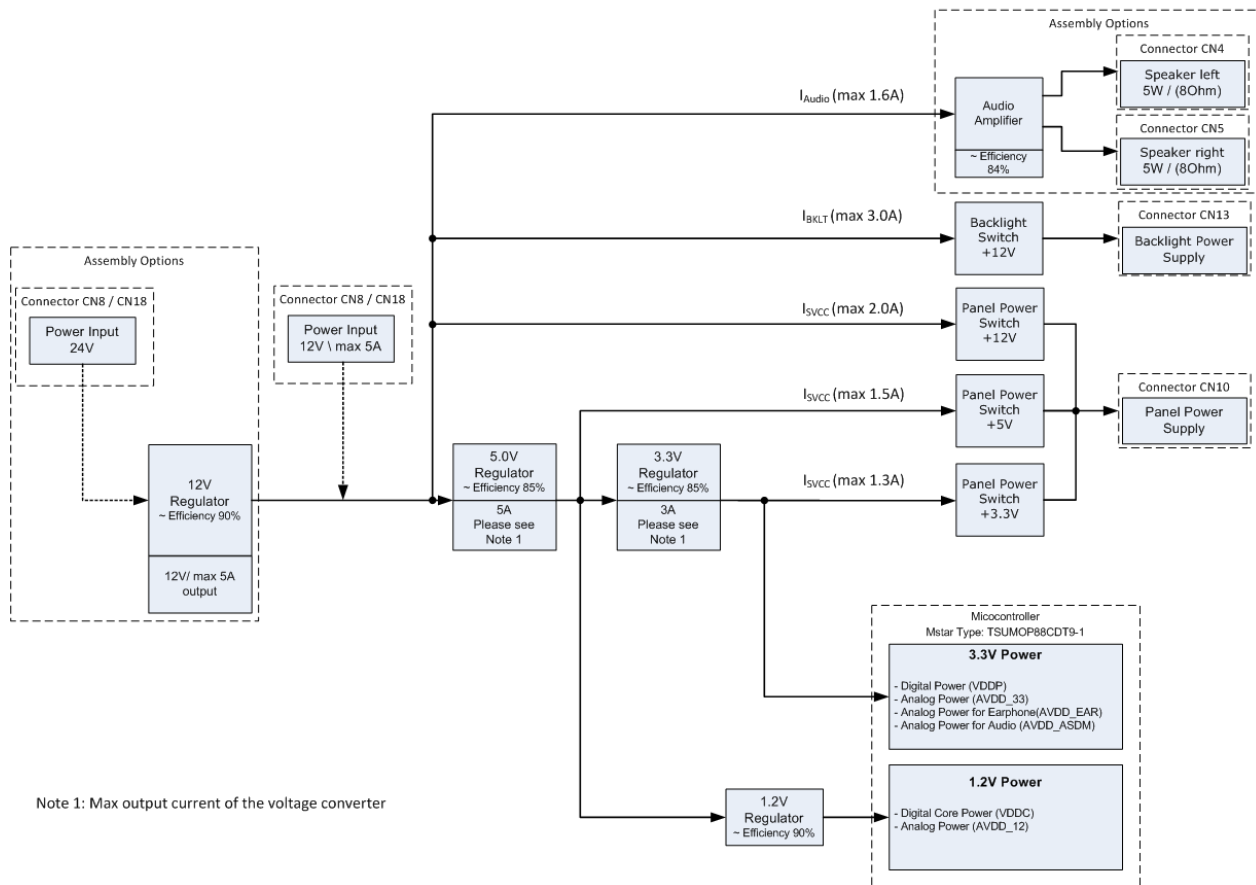

Note 1: Max output current of the voltage converter

5 OSD Menu and User Controls

The OSD allows selection of input source and fine tuning of various functional parameters like brightness, contrast etc. These parameters can be adjusted via an external interface.

5.1 OSD Control through external Keypad

An OSD-Keypad can be used to control the OSD. There is a 4-Button and 6-Button OSD Keypad available. It depends on the factory settings of the firmware, which keypad is active. The 4/6-Button Keypad can be selected in the submenu: OSD Settings -> Keypad Layout

5.1.1 4-Button OSD Keypad ZU-02-398

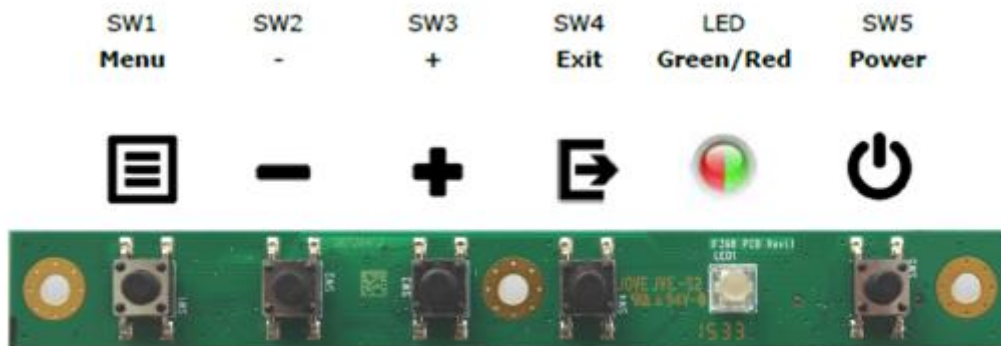

The following tables give you an overview about the functionality.

	Menu	-	+	Exit	LED	Power
General					See below	Power ON/OFF
OSD closed	Open OSD	Volume*	Brightness	Input Select		
OSD open	Select	Down/Left/-	Up/Right/+	Exit/Back		

*Volume dialog is only accessible on PrismaMediaECO-II boards with audio outputs or when input is not RGB.

LED Status:

- Green : Signal Found
- Green flashing : Searching Signal
- Red : Power Safe
- LED OFF : Power OFF
- Red flashing : No Panel Configuration is flashed

5.1.2 6-Button OSD Keypad ZU-02-378

For users that wish to use a 6-button OSD, a keypad with 6 OSD control buttons is available.

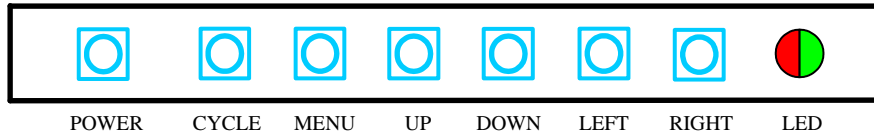
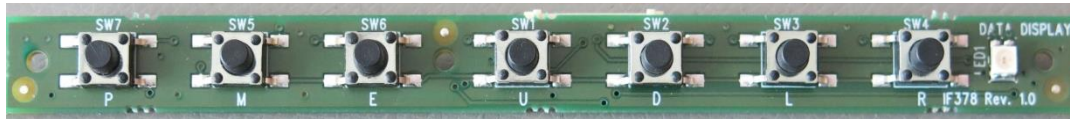

The following tables give you an overview about the functionality.

	Power	Cycle	Menu	Up	Down	Left	Right	LED
General	Power ON/OFF							See below
OSD closed		Input Select	Open OSD	Brightness	Volume*	Decrease brightness	Increase brightness	
OSD open		Select	Exit/Back	Up/+	Down/-	Left/-	Right/+	

*Volume dialog is only accessible on PrismaMediaECO-II boards with audio outputs or when input is not RGB.

LED Status:

- Green : Signal Found
- Green flashing : Searching Signal
- Red : Power Safe
- LED OFF : Power OFF
- Red flashing : No Panel Configuration is flashed

6 On- Screen-Menu

6.1 Brightness/Contrast Tab



Brightness: Brightness of the image can be controlled using this function, with left and right buttons after the brightness slider is selected. This function modifies RGB data to change the brightness.

Contrast: Allows <Contrast> adjustment in the Y domain. The modification affects all color channels and all input types and is a direct multiplication of the Y data after YUV black level adjustment.

6.2 Color Settings Tab

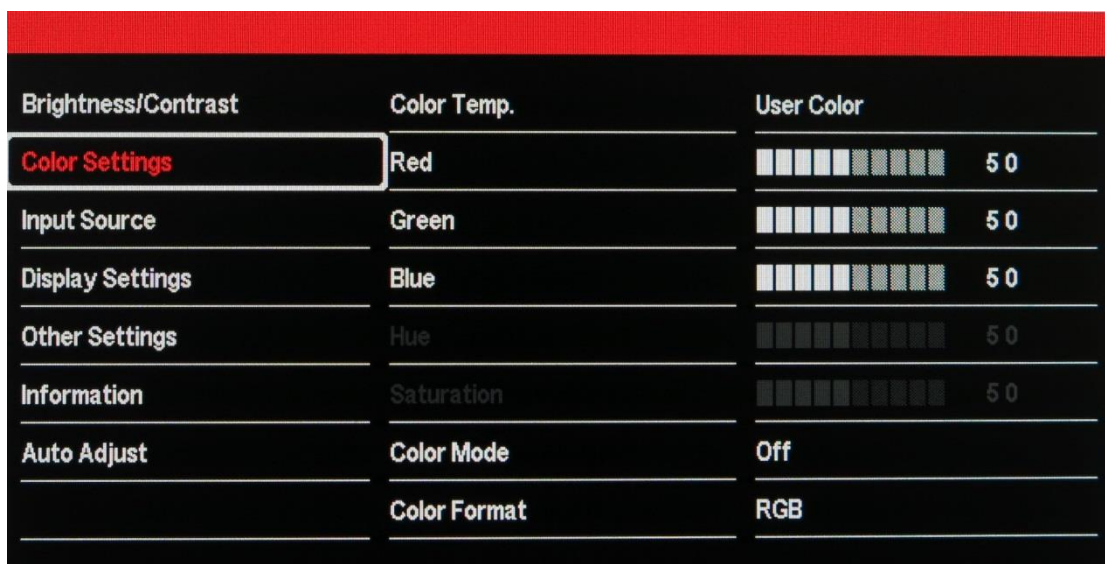

Color Temp: Allows selection of different color temperature schemes, predefined and custom. Available if the color space of the input is RGB.

Red, Green, Blue: Control the amount of the corresponding color components in the displayed image.

Hue: Allows <Hue> adjustment in the UV domain. The modification affects all color channels and all input types. Available if the color space of an input is not RGB.

Saturation: Allows <Saturation> adjustment in the UV domain. The modification affects all color channels and all input types. Available if the color space of an input is not RGB.

Color Format: Switches between RGB and YUV color spaces.

6.3 Input Source Tab

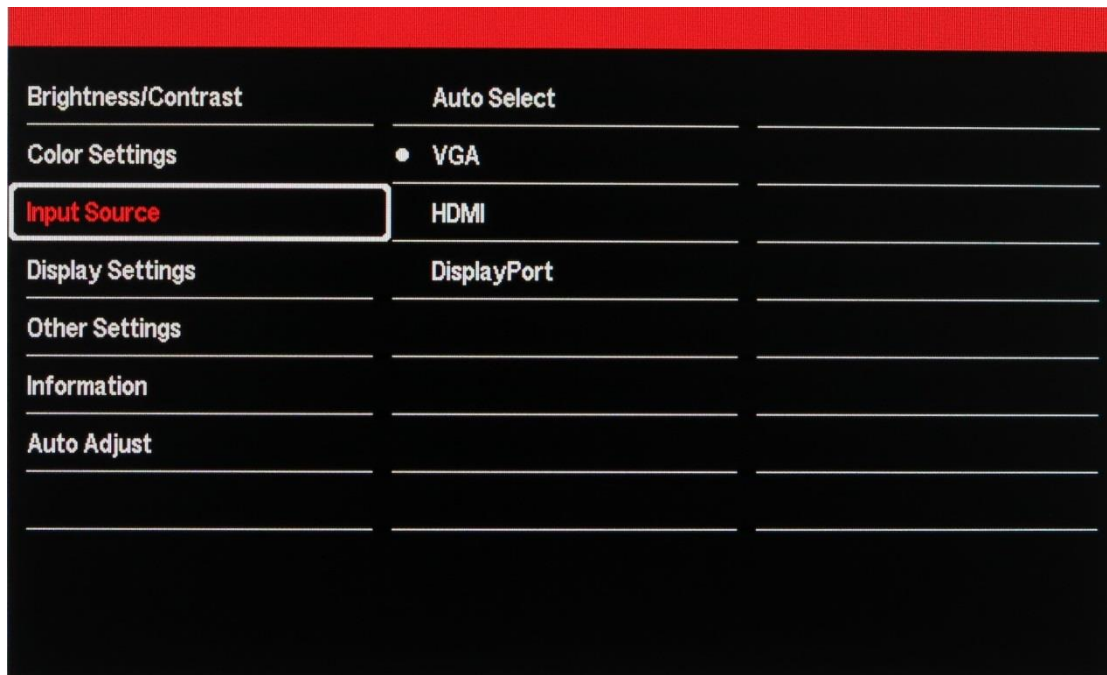

Enables the manual selection of the input source, **Auto Select** enables / disables input auto-detection

6.4 Display Settings Tab

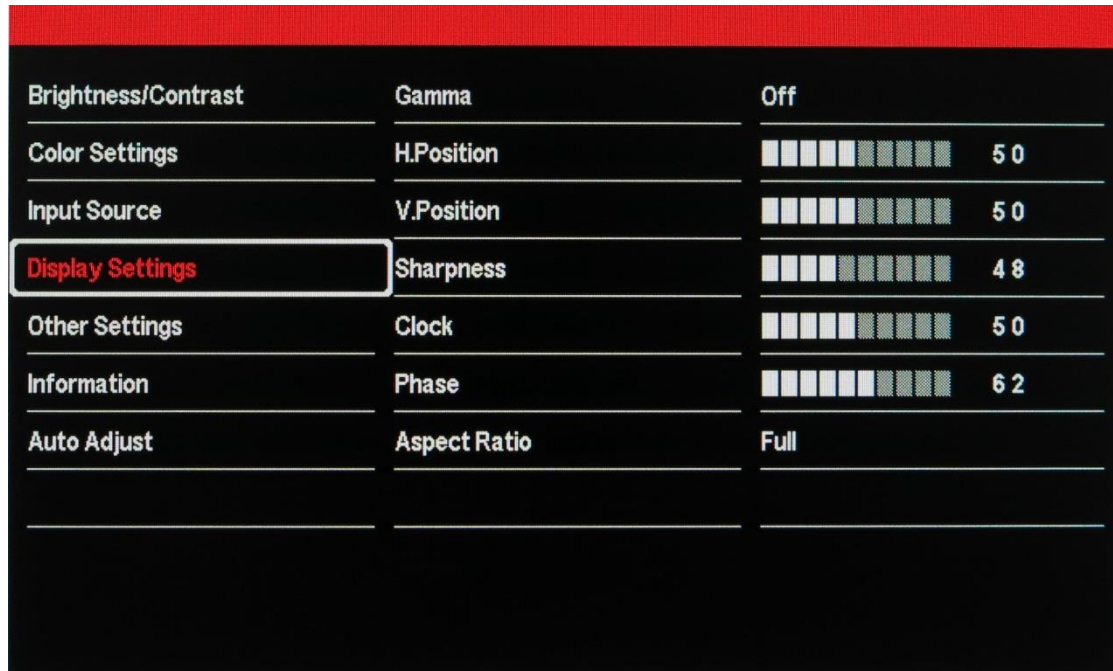

Gamma: Enables or disables the gamma correction.

H.Position: Allows the horizontal adjustment of the input image. (available only for the analog input)

V.Position: Allows the vertical adjustment of the input image. (available only for the analog input)

Sharpness: Allows <Sharpness> adjustment of the image. (available only for the analog input)

Clock: This function is a slider to adjust the sample clock of the analog interface. This is helpful for improving the image quality for non-standard display modes. (available only for the analog input)

Phase: This function is a slider to adjust the sampling phase of the analog interface. For optimum image quality, input pixels should be sampled at the ideal sampling points. (available only for the analog input)

Aspect Ratio: Allows adjustment of the display's width to height proportions.

6.5 Other Settings Tab

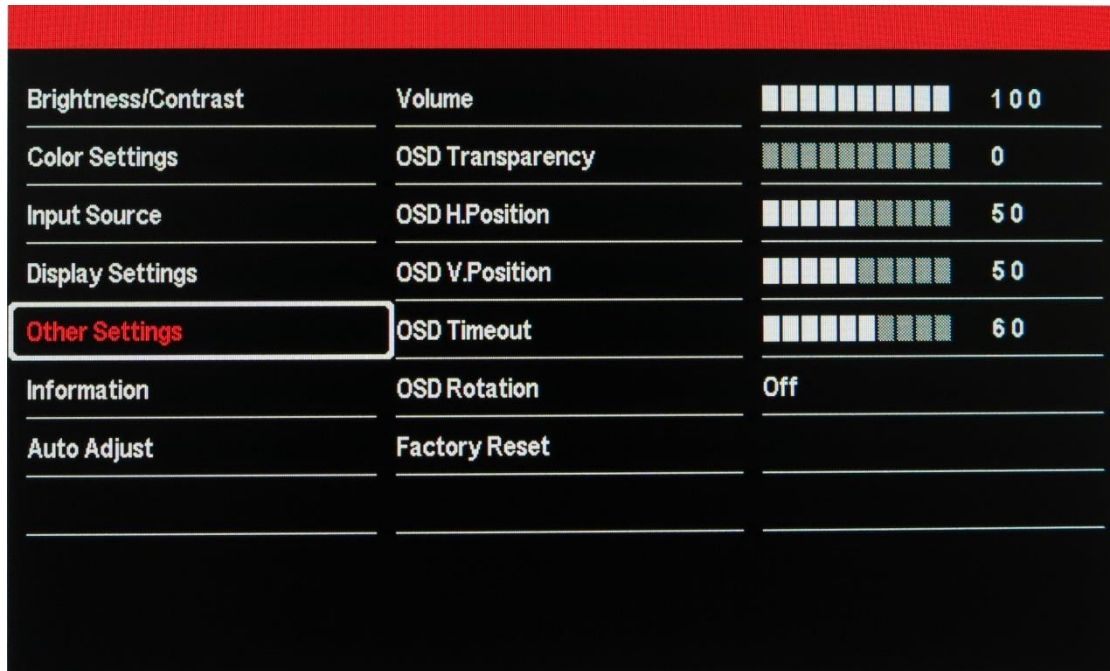

Volume: Sets the volume of the sound (available only for digital signals and when the board is outfitted with an audio output)

OSD Transparency: Sets the transparency level of the OSD Menu on the 0 to 5 scale (0 – not transparent, 5 – barely visible)

OSD H.Position: Sets the horizontal OSD Menu position on the screen (in percent of the horizontal screen resolution)

OSD V.Position: Sets the vertical OSD Menu position on the screen (in percent of the vertical screen resolution)

OSD Timeout: Selects how many seconds the OSD will remain active after the last action has been performed.

OSD Rotation: Rotates the OSD Menu by 90, 180 or 270 degrees.

Factory Reset: Resets the display settings to the default ones.

6.6 Information Tab

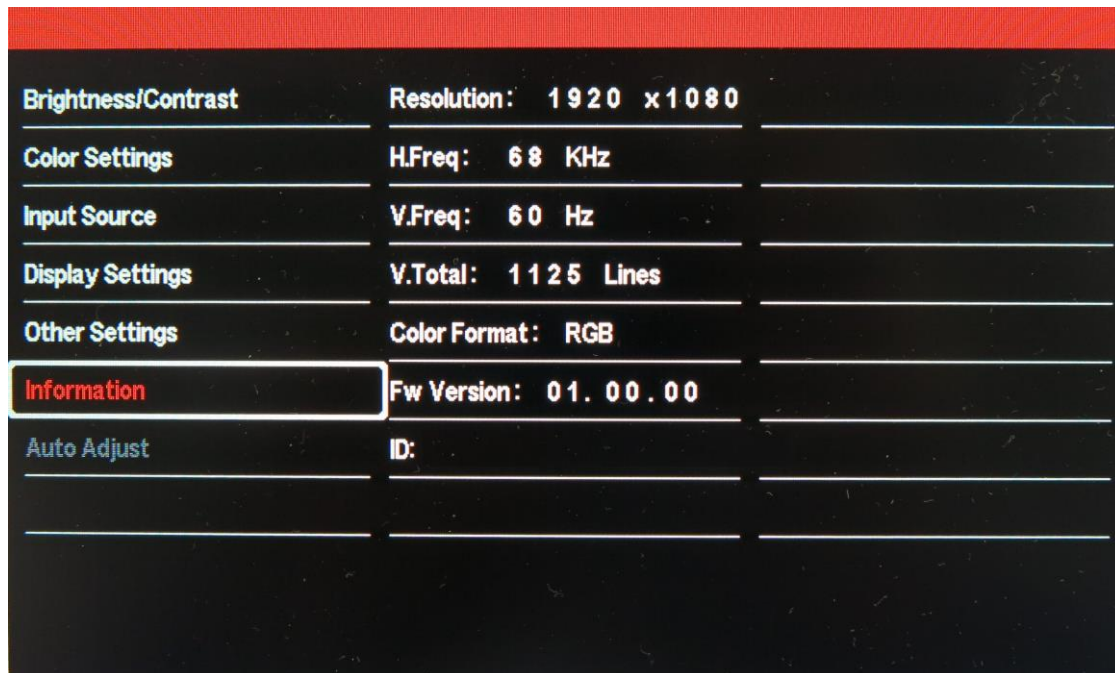

Input Resolution and FW revision and ID information.

6.7 Auto Adjust Tab

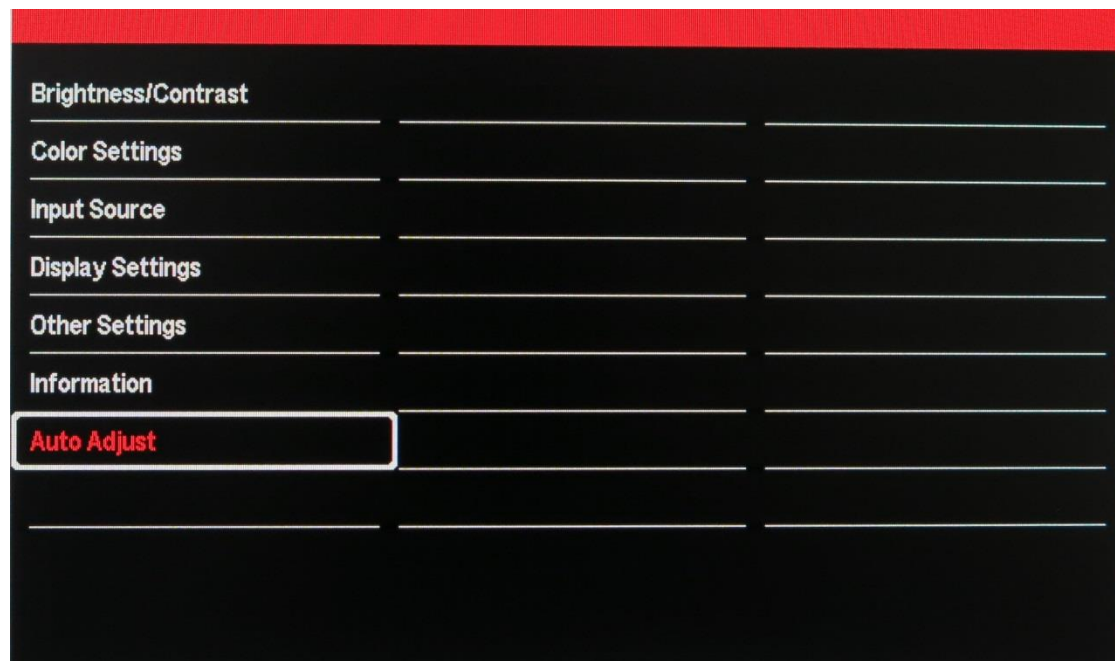

Performs the auto adjust (available only for the analog input).

6.8 Input Source Window

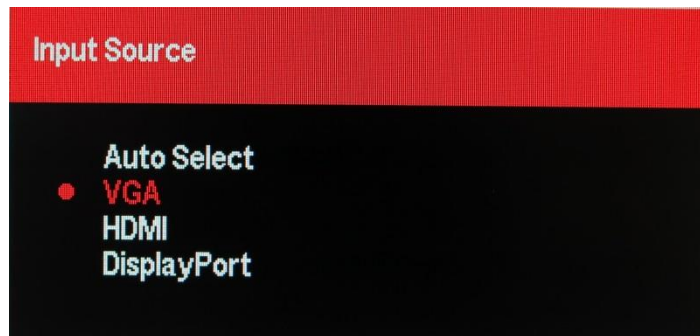

Select the input signal source without going into the main menu.

6.9 Volume Control

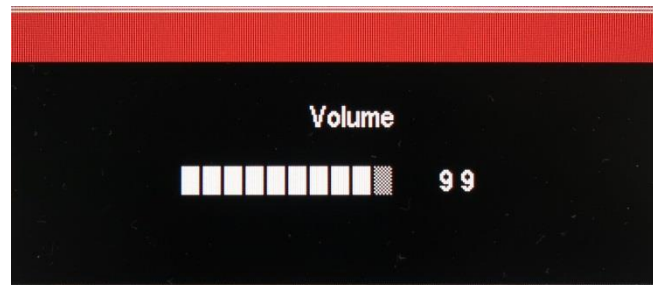

Controls the volume of the sound (available only for digital signals and when the board is outfitted with an audio output).

6.10 Brightness Control

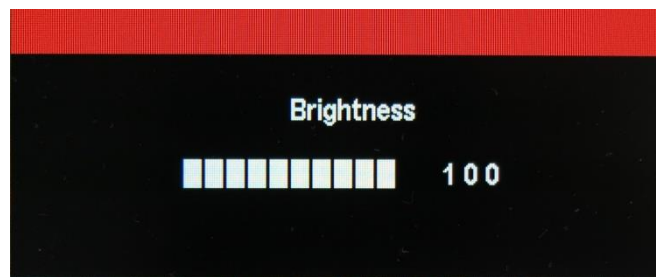

Controls the brightness of the display.

7 Supported Input Modes

The PrismaMediaECO-II can support the following input modes.

7.1 VGA

The PrismaMediaECO-II is equipped with one VGA connector CN1. The factory preset supported input modes include:

Resolution	Resolution
640 x 480 @ 60 Hz (VESA)	1360 x 768 @ 60 Hz
800 x 600 @ 60 Hz (VESA)	1366 x 768 @ 60 Hz
1024 x 768 @ 60 Hz (VESA)	1368 x 768 @ 60 Hz
1280 x 768 @ 60 Hz	1600 x 1200 @ 60 Hz (VESA)
1280 x 800 @ 60 Hz	1920 x 1200 @ 60 Hz
1280 x 1024 @ 60 Hz (VESA)	1920 x 1080 @ 60 Hz

7.2 HDMI – Graphics

The PrismaMediaECO-II is equipped with the HDMI connector, CN2. The factory preset supported input modes include:

Resolution	Resolution
640 x 480 @ 60 Hz (VESA)	1360 x 768 @ 60 Hz
800 x 600 @ 60 Hz (VESA)	1366 x 768 @ 60 Hz
1024 x 768 @ 60 Hz (VESA)	1368 x 768 @ 60 Hz
1280 x 768 @ 60 Hz	1600 x 1200 @ 60 Hz (VESA)
1280 x 800 @ 60 Hz	1920 x 1200 @ 60 Hz
1280 x 1024 @ 60 Hz (VESA)	1920 x 1080 @ 60 Hz

7.3 HDMI – Video

The factory preset supported input modes include:

Resolution	Resolution
720 x 480 @ 60	1280 x 720 @ 60
720 x 576 @ 50	1920 x 1080 @ 50
1280 x 720 @ 50	1920 x 1080 @ 60

7.4 DisplayPort

The PrismaMediaECO-II is equipped with one DP connector, CN3. The factory preset supported input modes include:

Resolution	Resolution
640 x 480 @ 60 Hz (VESA)	1360 x 768 @ 60 Hz
800 x 600 @ 60 Hz (VESA)	1366 x 768 @ 60 Hz
1024 x 768 @ 60 Hz (VESA)	1368 x 768 @ 60 Hz
1280 x 768 @ 60 Hz	1600 x 1200 @ 60 Hz (VESA)
1280 x 800 @ 60 Hz	1920 x 1200 @ 60 Hz
1280 x 1024 @ 60 Hz (VESA)	1920 x 1080 @ 60 Hz

Note that PrismaMediaECO-II is performing Source Detection according to DisplayPort 1.1a specification. If your source is not detected by PrismaMediaECO-II, please check if the pull-up and pull-down requirements for the AUX-channel are fulfilled:

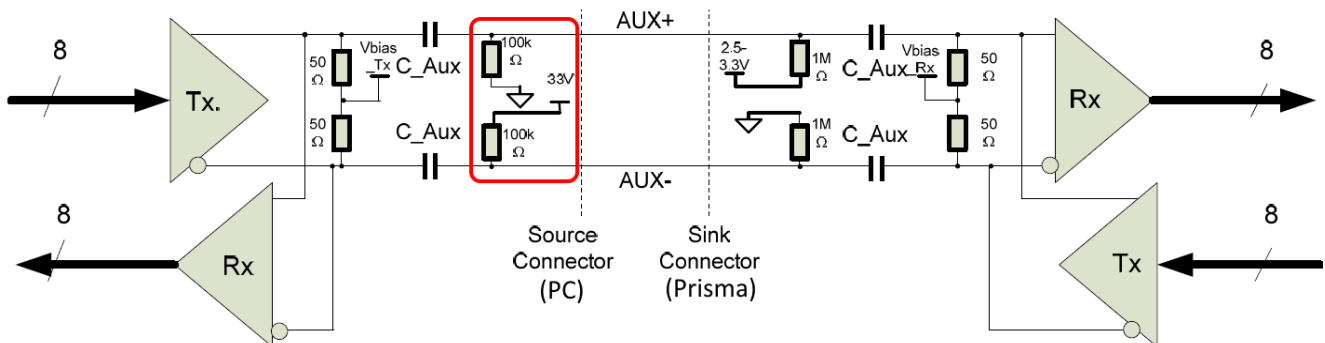

The DisplayPort Source Device must weakly pull down the AUX+ line and weakly pull up the AUX- line with 100kΩ (+/-5%) resistors between the AC-coupling capacitor and the Source Connector to assist detection of DisplayPort Source and Powered DisplayPort Source by the Sink Device.

(VESA DisplayPort Standard, Version 1, Revision 1a, January 11, 2008, chapter 3.4)

8 Audio Support

8.1 Audio Input

Digital Inputs (embedded into the interfaces)

- DisplayPort (DP)
- HDMI

8.2 Audio Output

- 2x5W@8Ω analog output via CN4 / CN5 (measured with 0dBFS level 1kHz sine wave)
- (Optional) Audio output gain level can be increased on customer request
- Headphone output (CN16)

8.2.1 AC Characteristics

TA= -40°C to 125°C, Audio power supply inputs = 12 V, RL= 8Ω

Item	Min.	Typ.	Max.	Unit	Note
THD+ N Total harmonic distortion + noise at RL= 8Ω, f = 1 kHz, Po= 5 W (half-power)		0.06		%	
Crosstalk at Po= 1 W, Gain= 20 dB, f = 1 kHz		-100		dB	
SNR Signal-to-noise ratio at maximum output (THD+N< 1%), f = 1 kHz, Gain= 20 dB, A-weighted		102		dB	

9 Absolute Maximum Ratings

Item	Symbol	Min.	Max.	Unit	Note
Supply Voltage (12V Version) [PR-01-220, PR-01-221]	$V_{in(12V)}$	0	14	VDC	1, 2, 3, 4
Supply Voltage (24V Version) [PR-01-222, PR-01-224]	$V_{in(24V)}$	0	28	VDC	1, 2, 3
Storage Temperature	T_{St}	-20	+85	°C	
Operating Temperature	T_{Op}	-20	+70	°C	5

Note (1) Within operating temperature range.

Note (2) Supply voltage limits are for the PrismaMediaECO-II, panel/inverter supply limits must be met as well, if the panel is +12V and the inverter is to be powered through the PrismaMediaECO-II board.

Note (3) Permanent damage to the device may occur if maximum values are exceeded.

Note (4) Supply voltage limits are for the PrismaMediaECO-II; inverter supply limits must be met as well, if the inverter is to be powered through the PrismaMediaECO-II board.

Note (5) All power drawn from the board [PR-01-222, PR-01-224] must not exceed 70W (Supply Voltage 24V)

10 Electrical Characteristics

All measurements done at 25°C ambient temperature.

Item	Condition	MIN.	TYP.	MAX.	Unit	Note
Supply Voltage (12V Version) [PR-01-220, PR-01-221]		11.7	12	12.3	VDC	
Input Current (12V Version) [PR-01-220, PR-01-221]	$V_{in(12V)}$			5	A	
Supply Voltage (24V Version) [PR-01-222, PR-01-224]		20	24	26	VDC	1
Input Current (24V Version) [PR-01-222, PR-01-224]	$V_{in(24V)}$			3	A	1
Current Consumption (24V)	Power-OFF/ Sleep	-	87	97	mA	
	Board only [PR-01-222]	-	137	147	mA	
	Board only [PR-01-224]	-	125	135	mA	
Current Consumption (12V)	Power-OFF/ Sleep		67	77	mA	
	Board only [PR-01-220]		176	186	mA	
	Board only [PR-01-221]		142	152	mA	

Note (1) All power drawn from the board [PR-01-222, PR-01-224] must not exceed 70W (Supply Voltage 24V), 60W (Supply Voltage 20V)

10.1 Maximal allowed power Consumption for TFT Panels (V_{SVCC})

Item	Symbol	Max.	Unit	Note
3.3V, (5V), [12V] (V_{SVCC}) Panel power	I_{SVCC}	1.3, (1.5), [2]	A	

10.2 Maximal allowed power Consumption for backlight inverter (V_{BKLT})

Item	Symbol	Max.	Unit	Note
+12V Backlight power on CON13	I_{BKL}	3.0	A	

11 Mechanical Specification

ITEM	DESCRIPTION	REMARKS
Length	160 mm	± 0.5 mm
Width	110 mm	± 0.2 mm
Height (PCB)	1.6 mm	± 0.1 mm
Height (Bottom side)	1.8 mm	± 0.2 mm
Height (Top side)	14.3 mm	± 0.2 mm
Weight [PR-01-220_1.2_00]	105 g	± 3 g
Weight [PR-01-221_1.1_01]	90 g	± 3 g
Weight [PR-01-222_1.2_00]	112 g	± 3 g
Weight [PR-01-224_1.1_03]	96 g	± 3 g

11.1 Mechanical Drawing

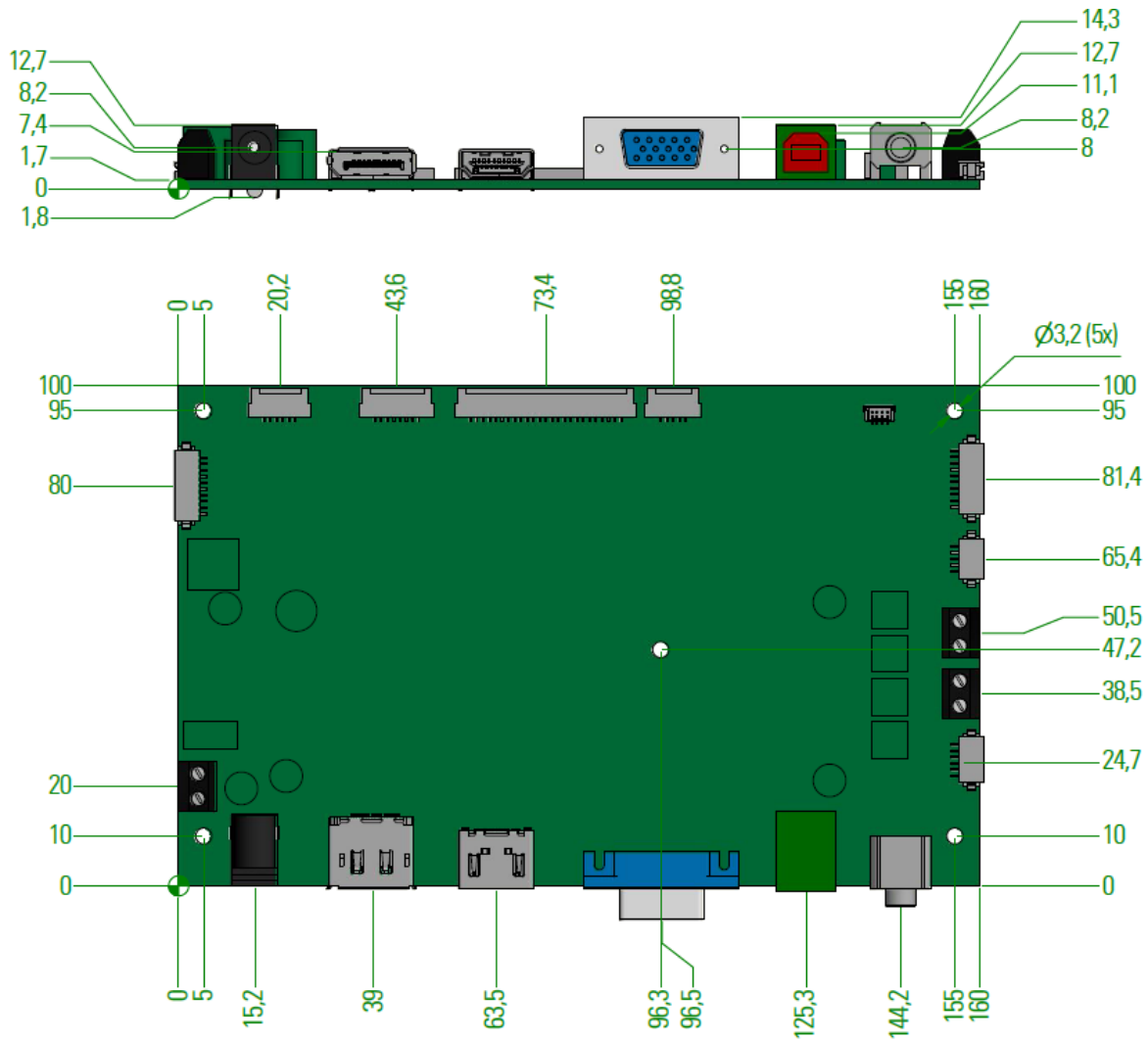

12 Connector Overview

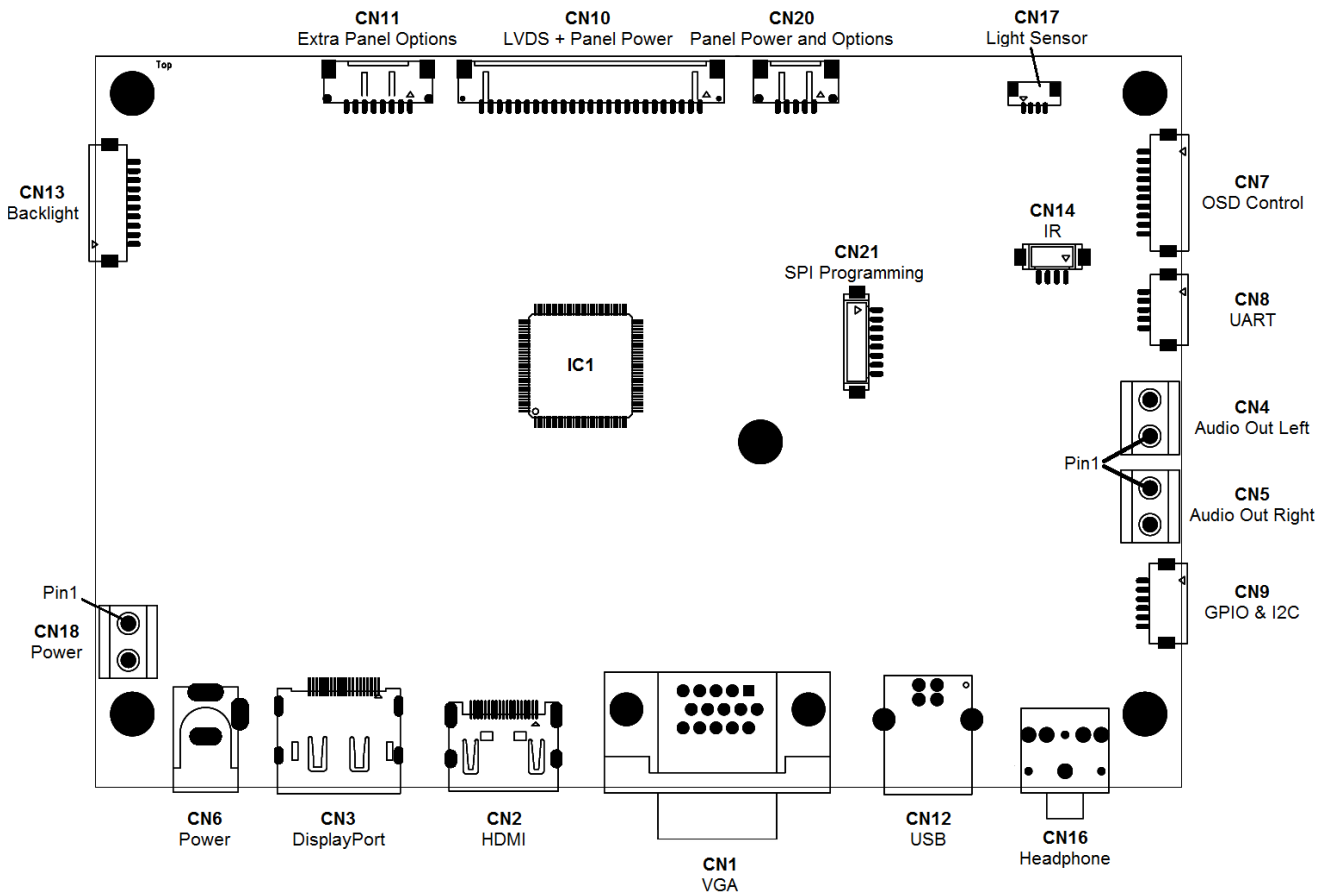

Connectors	Description	Type (Ref only)	Manufacture (Ref only)
CN1	VGA Input	15-pin H-DSUB female	Zhenqin
CN2	HDMI Input	47151-1001	Molex
CN3	DisplayPort Input	47272-0001	Molex
CN4	Speaker left out (OPTIONAL)	Screw terminal block, 5mm, 2 pins	PTR
CN5	Speaker right out (OPTIONAL)	Screw terminal block, 5mm, 2 pins	PTR
CN6	DC Power Jack (5A)	PJ-002AH	CUI Incorporated
CN7	OSD Control	DF13-10P-1.25H	Hirose
CN8	UART/GProbe	DF13-5P-1.25V	Hirose
CN9	External GPIO/I2C	DF13-6P-1.25H	Hirose
CN10	Dual LVDS	DF14-25P-1.25H	Hirose
CN11	Ext. Panel Options (optional)	DF14-8P-1.25H	Hirose
CN12	USB Type-B (OPTIONAL)	USBR-B-S-F-O-TH-R	Samtec
CN13	Backlight Power Supply	DF13-10P-1.25H	Hirose
CN14	Infrared (OPTIONAL)	DF13-4P-1.25V-21	Hirose

CN16	Headphone (OPTIONAL)	STX-3200-5NB	Kycon
CN17	Light Sensor (OPTIONAL)	501331-0407	Molex
CN18	Power Supply Input	Screw Terminal (5mm)	
CN20	Additional LVDS power	DF14-5P-1.25H	Hirose
CN21	SPI Programming	DF13-8P-1.25V	Hirose

12.1 Input Connectors

RGB – ANALOG INPUT CONNECTOR CN1		
Pin	Signal	Description
1	RED	Analog Red
2	GREEN	Analog Green
3	BLUE	Analog Blue
4	NC	Not connected
5	VGA_PLUG	Connect it to GND for cable detection
6	GND	Ground
7	GND	Ground
8	GND	Ground

Pin	Signal	Description
9	VGA_5V	Fused VCC
10	GND	Ground
11	NC	Not Connect
12	VGA_SDA	DDC Data
13	HSYNC	Horizontal Sync Input
14	VSYNC	Vertical Sync Input
15	VGA_SCL	DDC Clock

HDMI CONNECTOR CN2		
Pin	Signal	Description
1	TMDS2+	Differential TMDS Data 2+
2	GND	Ground
3	TMDS2-	Differential TMDS Data 2-
4	TMDS1+	Differential TMDS Data 1+
5	GND	Ground
6	TMDS1-	Differential TMDS Data 1-
7	TMDS0+	Differential TMDS Data 0+
8	GND	Ground
9	TMDS0-	Differential TMDS Data 0-
10	TMDSCLK+	Differential TMDS Clock+

Pin	Signal	Description
11	GND	Ground
12	TMDSCLK-	Differential TMDS Clock-
13	CEC	Consumer Electronic Control
14	Reserved	
15	HDMI_SCL	DDC Clock
16	HDMI_SDA	DDC Data
17	HDMI_PLUG	Connect it to GND for cable detection
18	HDMI_VCC	+5V
19	Hot Plug	Hot Plug Detection

DISPLAYPORT CONNECTOR CN3		
Pin	Signal	Description
1	DP3-_IN	Pair-3 negative
2	GND	Ground
3	DP3+_IN	Pair-3 positive
4	DP2-_IN	Pair-2 negative
5	GND	Ground
6	DP2+_IN	Pair-2 positive
7	DP1-_IN	Pair-1 negative
8	GND	Ground
9	DP1+_IN	Pair-1 positive
10	DP0-_IN	Pair-0 negative

Pin	Signal	Description
11	GND	Ground
12	DP0+_IN	Pair-0 positive
13	GND	Ground
14	GND	Ground
15	DPA+_IN	Aux channel positive
16	GND	Ground
17	DPA-_IN	Aux channel negative
18	HPD	Hot Plug Detect
19	Power Return	Return for +3.3V
20	+3.3V_DP	DisplayPort +3.3V

POWER SUPPLY CONNECTOR CN6		
Pin	Signal	Description
Center	+12V	12V Power supply (up to 5A)

Pin	Signal	Description
Bottom	GND	Ground

POWER SUPPLY CONNECTOR CN18		
Pin	Signal	Description
1	+12V	12V Power supply (up to 5A)

Pin	Signal	Description
2	GND	Ground

OSD CONTROL PANEL CONNECTOR CN7		
Pin	Signal	Description
1	+3.3V	+3.3V power
2	GND	Ground
3	LBADC_IN1	Low Bandwidth ADC
4	GND	Ground
5	LED_RED	Status LED red (Sleep Mode)

Pin	Signal	Description
6	LED_GREEN	Status LED green (signal good)
7	NC	Not connected
8	+3.3V	+3.3V power
9	+5V	+5V power
10	GND	Ground

UART CONNECTOR CN8		
Pin	Signal	Description
1	TX	Serial Output
2	RX	Serial Input
3	+3.3V	3.3V Power supply

Pin	Signal	Description
4	+5V	5V Power supply
5	GND	Ground

SPI PROGRAMMING HEADER CN21

Pin	Signal	Description
1	SPI_PROG_EN#	Enable Signal
2	SPI_CLK_FLASH	SPI Clock
3	SPI_SI_FLASH	SPI_SI
4	SPI_SO_FLASH	SPI_SO

Pin	Signal	Description
5	SPI_CS_FLASH	SPI_CS
6	MSTAR_RESET_N	MSTAR_RESET_N
7	GND	GND
8	+3.3V Output	+3.3V Output

USB B-TYPE CONNECTOR CN12 (OPTIONAL)

Pin	Signal	Description
1	VUSB	+5V USB inputpower
2	USBDM	-DATA

Pin	Signal	Description
3	USBDP	+DATA
4	GND	Ground

Remote control IR-amplifier CN14 (optional)

Pin	Signal	Description
1	IR	Amplified IR signal
2	+3.3V	3.3V Power supply

Pin	Signal	Description
3	+5V	5V Power supply
4	GND	Ground

LIGHT SENSOR CONNECTOR CN17 (optional)

Pin	Signal	Description
1	+3.3V	+3.3V power
2	GND	Ground

Pin	Signal	Description
3	SCL	I2C clock
4	SDA	I2C data

12.2 Output Connectors

SPEAKER LEFT OUT CONNECTOR CN4 (OPTIONAL)

Pin	Signal	Description
1	L-	Left audio negative

SPEAKER RIGHT OUT CONNECTOR CN5 (OPTIONAL)

Pin	Signal	Description
1	R-	Right audio negative

LVDS CONNECTOR CN10

Pin	Signal	Description
1	SVCC	Switched panel power supply +3.3V/ +5V/ +12V (fused)
2		
3	GND	Ground
4		
5	TXB3+	LVDS data 1st pixel
6	TXB3-	LVDS data 1st pixel
7	TXBCL+	LVDS clock 1st pixel
8	TXBCL-	LVDS clock 1st pixel
9	TXB2+	LVDS data 1st pixel
10	TXB2-	LVDS data 1st pixel
11	TXB1+	LVDS data 1st pixel
12	TXB1-	LVDS data 1st pixel
13	TXB0+	LVDS data 1st pixel

Extra Panel Control Options CN11 (optional)

Pin	Signal	Description
1	GND	Ground
2	NC	Not connected
3	NC	Not connected
4	NC	Not connected

Pin	Signal	Description
2	L+	Left audio positive

Pin	Signal	Description
2	R+	Right audio positive

Pin	Signal	Description
14	TXB0-	LVDS data 1st pixel
15	TXA3+	LVDS data 2nd pixel
16	TXA3-	LVDS data 2nd pixel
17	TXACL+	LVDS clock 2nd pixel
18	TXACL-	LVDS clock 2nd pixel
19	TXA2+	LVDS data 2nd pixel
20	TXA2-	LVDS data 2nd pixel
21	TXA1+	LVDS data 2nd pixel
22	TXA1-	LVDS data 2nd pixel
23	TXA0+	LVDS data 2nd pixel
24	TXA0-	LVDS data 2nd pixel
25	EBKL	Enable backlight signal

Pin	Signal	Description
5	NC	Not connected
6	LVDS_OPT_1	+3.3V/GND selectable
7	LVDS_OPT_2	+3.3V/GND selectable
8	LVDS_OPT_3	+5V/+3.3V/GND selectable

BACKLIGHT SUPPLY CONNECTOR CN13

Pin	Signal	Description
1	BKLT_+12V	Backlight power supply
2	GND	Ground
3	BKLT_EN	Enable backlight signal
4	BRT_ADJ	Brightness control signal
5	NC	Not connected

Pin	Signal	Description
6	NC	Not connected
7	+12V	Backlight power supply
8	+12V	
9	GND	Ground
10	GND	

HEADPHONE OUT CONNECTOR (3.5mm jack) CN16 (OPTIONAL)

Pin	Signal	Description
Tip	HPL_OUT	Headphone left
Ring	HPR_OUT	Headphone right

Pin	Signal	Description
Sleeve	GND	Ground

PANEL EXTRA POWER CONNECTOR CN20

Pin	Signal	Description
1	LVDS_OPT_0	FW selectable option pin +3.3V/ +5V/ GND
2	SVCC	Panel power supply +3.3V/ +5V/ +12V
3	SVCC	

Pin	Signal	Description
4	GND	Ground
5	GND	Ground

12.3 I/O Connector

There are 2 GPIOs connected to CN9, which can be configured as either input or output, using custom firmwares. There also is an I2C connection, for control of external I2C devices.

External GPIO/I2C CN9

Pin	Signal	Description
1	+3.3V	3.3V power supply
2	EXT_GPIO_0	External GPIO 0
3	EXT_GPIO_1	External GPIO 1

Pin	Signal	Description
4	SCL	I2C Clock
5	SDA	I2C Data
6	GND	Ground

*External GPIO pins are open-drain, pulled up to 3.3V by 4.7kΩ resistor

13 Supported Panels and Backlights (Inverter/Converter)

Panels and Backlights Options (Note 1)	Hardware Options
Panel Voltage	3.3V
	5V
	12V
Pixel Per Clock	1
	2
Option Pin 0 Voltage Level	0V
	3.3V
	5.0V
Option Pin 1 Voltage Level	0V
	3.3V
Option Pin 2 Voltage Level	0V
	3.3V
Option Pin 3 Voltage Level	0V
	3.3V
	5V
Backlight Voltage	12V
Backlight Control Type	Analog
	PWM
Voltage Level of PWM Signal	3.3V
	5V
Analog Voltage Level Range	0V - 5V
Voltage Level of Backlight Enable Signal	3.3V
	5V

14 Hardware Information

Part Number	24V Input Voltage	12V Input Voltage	USB	Audio	Operating Temperature Range	Status
PR-01-220	O	X	X	X	-20°C – 70°C	Active
PR-01-221	O	X	O	O	-20°C – 70°C	Active
PR-01-222	X	O	X	X	-20°C – 70°C	Active
PR-01-224	X	O	O	O	-20°C – 70°C	Active

X = Available, O = Not available

Our company network supports you worldwide with offices in Germany, Austria, Switzerland, the UK and the USA. For more information please contact:

Headquarters

Germany



FORTEC Elektronik AG

Augsburger Str. 2b
82110 Germering

Phone: +49 89 894450-0
E-Mail: info@forteca.de
Internet: www.forteca.de

Fortec Group Members

Austria



Distec GmbH Office Vienna

Nuschinggasse 12
1230 Wien

Phone: +43 1 8673492-0
E-Mail: info@distec.de
Internet: www.distec.de

Germany



Distec GmbH

Augsburger Str. 2b
82110 Germering

Phone: +49 89 894363-0
E-Mail: info@distec.de
Internet: www.distec.de

Switzerland



ALTRAC AG

Bahnhofstraße 3
5436 Würenlos

Phone: +41 44 7446111
E-Mail: info@altrac.ch
Internet: www.altrac.ch

United Kingdom



Display Technology Ltd.

Osprey House, 1 Osprey Court
Hichingbrooke Business Park
Huntingdon, Cambridgeshire, PE29 6FN

Phone: +44 1480 411600
E-Mail: info@displaytechnology.co.uk
Internet: www.displaytechnology.co.uk

USA



Apollo Display Technologies, Corp.

87 Raynor Avenue,
Unit 1 Ronkonkoma,
NY 11779

Phone: +1 631 5804360
E-Mail: info@apolloDisplays.com
Internet: www.apolloDisplays.com