



OUR GLOBAL
COMPETENCE
CENTRES

 APOLLO DISPLAY
TECHNOLOGIES



 DISTEC



 DISPLAY
TECHNOLOGY



Datasheet

BDS

BD-T055AZH-01

BD-01-001

The information contained in this document has been carefully researched and is, to the best of our knowledge, accurate. However, we assume no liability for any product failures or damages, immediate or consequential, resulting from the use of the information provided herein. Our products are not intended for use in systems in which failures of product could result in personal injury. All trademarks mentioned herein are property of their respective owners. All specifications are subject to change without notice.

Beverly Display Solutions Limited

PRODUCT SPECIFICATIONS

For Customer: _____

: APPROVAL FOR SPECIFICATION

Customer Model No. _____

: APPROVAL FOR SAMPLE

Module No.: BD-T055AZH-01

Date : 2018-07-09

Table of Contents

No.	Item	Page
1	Cover Sheet(Table of Contents)	
2	Revision Record	
3	General Specifications	
4	Outline Drawing	
5	Absolute Maximum Ratings	
6	Electrical Specifications	
7	Optical Characteristics	
8	Reliability Test Items and Criteria	
9	Precautions for Use of LCD Modules	

For Customer's Acceptance:

Approved By	Comment

PREPARED	CHECKED	VERIFIED BY QA DEPT	VERIFIED BY R&D DEPT
Jhxie			

3. General Specifications

BD-T055AZH-01 is a TFT-LCD module. It is composed of a TFT-LCD panel, driver IC, FPC, TP, a back light unit. The 5.46'' display area contains 1080 x1920 pixels and can display up to 16.7M colors. This product accords with ROHS environmental criterion.

Item	Contents	Unit	Note
LCD Type	TFT	-	
Display color	16.7M		
Viewing Direction	Free viewing	O'Clock	
Gray scale inversion direction	-	O'Clock	
Operating temperature	-20~+70	°C	
Storage temperature	-30~+80	°C	
Module size	Refer to outline drawing	mm	
Active Area(W×H)	68.04X120.96	mm	
Number of Dots	1080×RGB×1920	dots	
Controller	HX8399C	-	
Power Supply Voltage	2.8	V	
Outline Dimensions	Refer to outline drawing	-	
Backlight	14-LEDs (white)	pcs	
Weight	---	g	
Interface	MIPI	-	

Note 1: Color tune is slightly changed by temperature and driving voltage.

4.Outline.Drawing

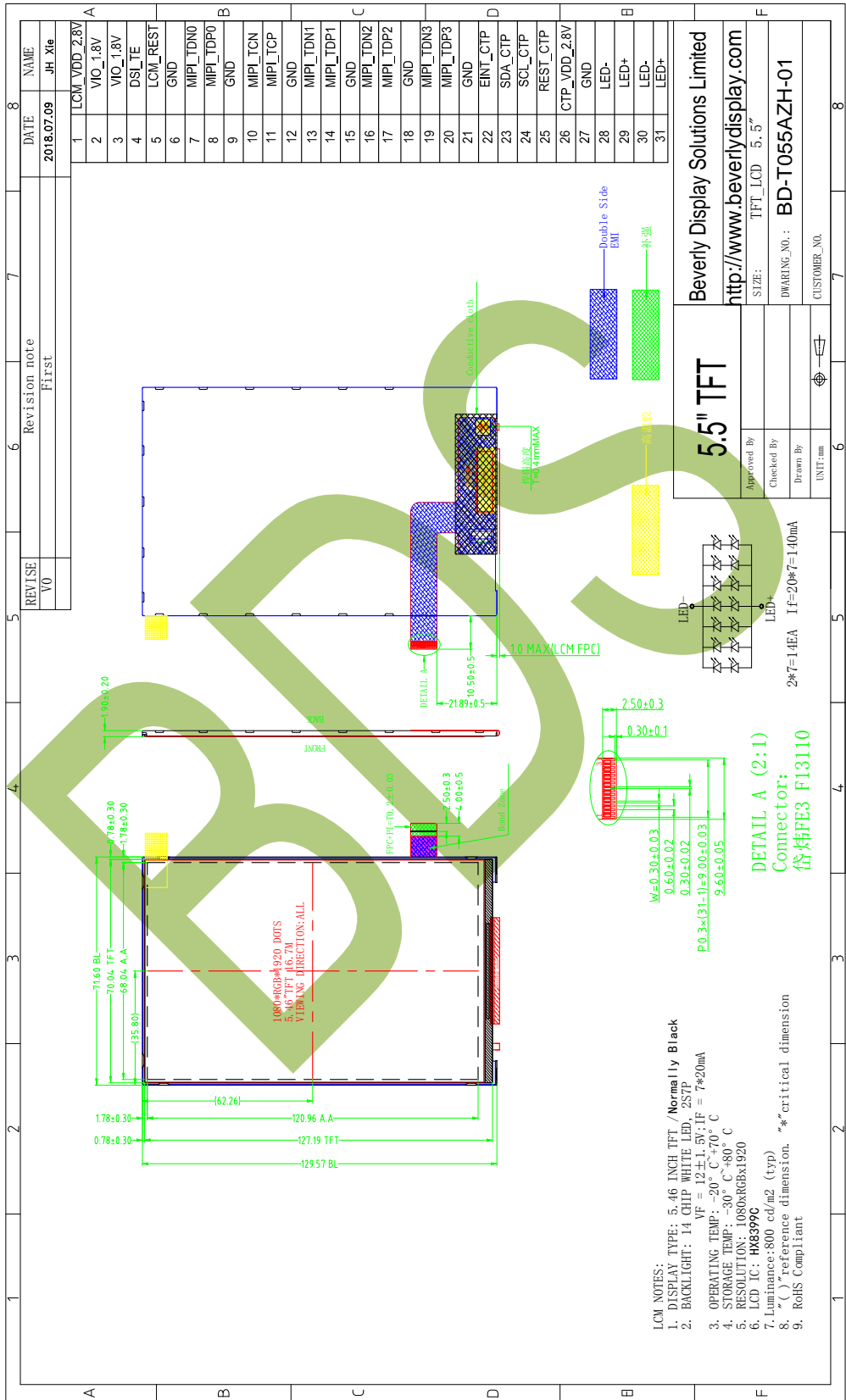

Beverly Display Solutions Limited

5. Absolute Maximum Ratings($T_a=25^\circ\text{C}$)

5.1 Electrical Absolute Maximum Ratings.($V_{SS}=0\text{V}$, $T_a=25^\circ\text{C}$)

Item	Symbol	Min.	Max.	Unit	Note
Power Supply Voltage	V_{DD}	-0.3	3.6	V	1, 2
Logic Signal Input /Output Voltage	IOV_{CC}	-0.3	3.3	V	

Notes:

1. If the module is above these absolute maximum ratings. It may become permanently damaged. Using the module within the following electrical characteristic conditions are also exceeded, the module will malfunction and cause poor reliability.
2. $V_{DD} > V_{SS}$ must be maintained.
3. Please be sure users are grounded when handing LCD Module.

5.2 Environmental Absolute Maximum Ratings.

Item	Storage		Operating		Note
	MIN.	MAX.	MIN.	MAX.	
Ambient Temperature	-30°C	80°C	-20°C	70°C	1,2
Humidity	-	-	-	-	3

1. The response time will become lower when operated at low temperature.
2. Background color changes slightly depending on ambient temperature.
The phenomenon is reversible.
3. $T_a \leq 40^\circ\text{C}$: 85%RH MAX.
 $T_a > 40^\circ\text{C}$: Absolute humidity must be lower than the humidity of 85%RH at 40°C .

6. Electrical Specifications

6.1 Electrical characteristics ($V_{SS}=0V, T_a=25^\circ C$)

Parameter	Symbol	Condition	Min	Typ	Max	Unit	Note	
Power supply	V_{DD}	$T_a=25^\circ C$	2.6	2.8	3.6	V		
	IOV_{CC}		1.65	1.8	3.3			
Input voltage	'H'	V_{IH}	$V_{DD}=2.8V$	$0.7V_{VDD}$	-	V_{VDD}	V	
	'L'	V_{IL}	$V_{DD}=2.8V$	0	-	$0.3V_{VDD}$	V	
Current Consumption	I_{CC1}	Normal mode	-	40	-	mA		
	I_{CC2}	Sleep mode	-	0.2	-	mA		
Clock Frequency	FCLK	-	-	88	-	MHz		

Note:1: Tested in 1×1 chessboard pattern.

6.2 LED backlight specification ($V_{SS}=0V, T_a=25^\circ C$)

Item	Symbol	Condition	Min	Typ	Max	Unit	Note
Supply voltage	V_f	$I_f=20 \times 7mA$		12		V	
Uniformity	ΔB_p	$I_f=20 \times 7mA$	75			%	
LED life time	-	$I_f=20mA$	-	20000	-	Hours	

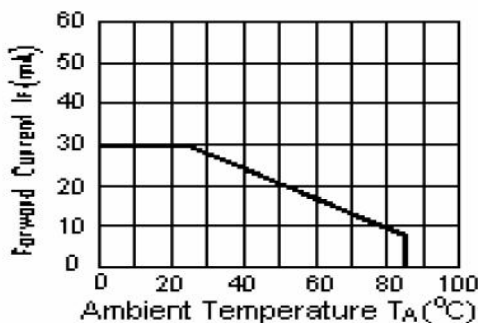

I_{LED} VS TEMP

Pin No.	Symbol	I/O	Function
1	VDD_2.8V	P	Power supply
2-3	VIO_1.8V	P	Digital IO Pad power supply
4	DSI_TE	O	Tearing effect output
5	LCM_RESET	I	Reset the display
6	GND	P	Ground.
7	MIPI_TDN0	I	Negative polarity of low voltage differential data signal
8	MIPI_TDP0	I	Positive polarity of low voltage differential data signal
9	GND	P	Ground.
10	MIPI_TCN	I	Negative polarity of low voltage differential clock signal
11	MIPI_TCP	I	Positive polarity of low voltage differential clock sign
12	GND	P	Ground.
13	MIPI_TDN1	I	Negative polarity of low voltage differential data signal
14	MIPI_TDP1	I	Positive polarity of low voltage differential data signal
15	GND	P	Ground.
16	MIPI_TDN2	I	Negative polarity of low voltage differential data signal
17	MIPI_TDP2	I	Positive polarity of low voltage differential data signal
18	GND	P	Ground.
19	MIPI_TDN3	I	Negative polarity of low voltage differential data signal
20	MIPI_TDP3	I	Positive polarity of low voltage differential data signal
21	GND	P	Ground.
22	EINT_CTP	I	Control of the CTP pins
23	SDA_CTP	I	
24	SCL_CTP	I	
25	RESET_CTP	I	
26	VDD_2.8V	P	
27	GND	P	Ground.
28	LED-	P	LED back light(Cathode)
29	LED+	P	LED back light(Anode)
30	LED-	P	LED back light(Cathode)
31	LED+	P	LED back light(Anode)

6.3
Int
erf
ac
e
sig
nal
s

7. Optical Characteristics

Item	Symbol	Condition	Min.	Typ.	Max.	Unit	Note	
Brightness	Bp	$\theta=0^\circ$		800		Cd/m ²	1	
Uniformity	Δ Bp	$\Phi=0^\circ$	75		-	%	1,2	
Viewing Angle	3:00	Cr \geq 10	-	80	-	Deg	3	
	6:00		-	80	-			
	9:00		-	80	-			
	12:00		-	80	-			
Contrast Ratio	Cr		1200	1500		-	4	
Response Time	T _r +T _f	$\theta=0^\circ$ $\Phi=0^\circ$	-	-	35	ms	5	
			-			ms		
Color of CIE Coordinate	W	x		0.295		-	1,6	
		y		0.325		-		
	R	x		0.642		-		
		y		0.336		-		
	G	x	$\theta=0^\circ$ $\Phi=0^\circ$		0.295			-
		y			0.609			-
	B	x			0.149			-
		y			0.060			-
NTSC Ratio	-			65	70		%	

Note: The parameter is slightly changed by temperature, driving voltage and materiel

Note 1: The data are measured after LEDs are turned on for 5 minutes. LCM displays full white. The brightness is the average value of 9 measured spots. Measurement equipment PR-705 (Φ 8mm)

Measuring condition:

- Measuring surroundings: Dark room.

Beverly Display Solutions Limited

- Measuring temperature: $T_a=25\text{ }^\circ\text{C}$.
- Adjust operating voltage to get optimum contrast at the center of the display.

Measured value at the center point of LCD panel after more than 5 minutes while backlight turning on.

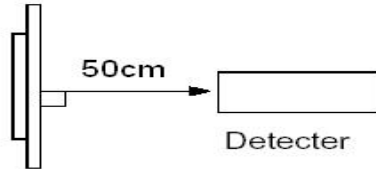

Note 2: The luminance uniformity is calculated by using following formula.

$$\Delta Bp = Bp (\text{Min.}) / Bp (\text{Max.}) \times 100 (\%)$$

$Bp (\text{Max.})$ = Maximum brightness in 9 measured spots

$Bp (\text{Min.})$ = Minimum brightness in 9 measured spots.

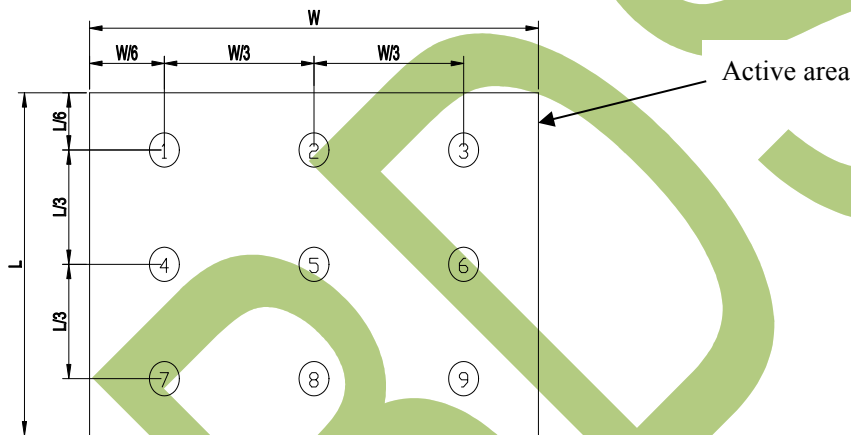

Note 3: The definition of viewing angle:

Refer to the graph below marked by θ and ϕ

Beverly Display Solutions Limited

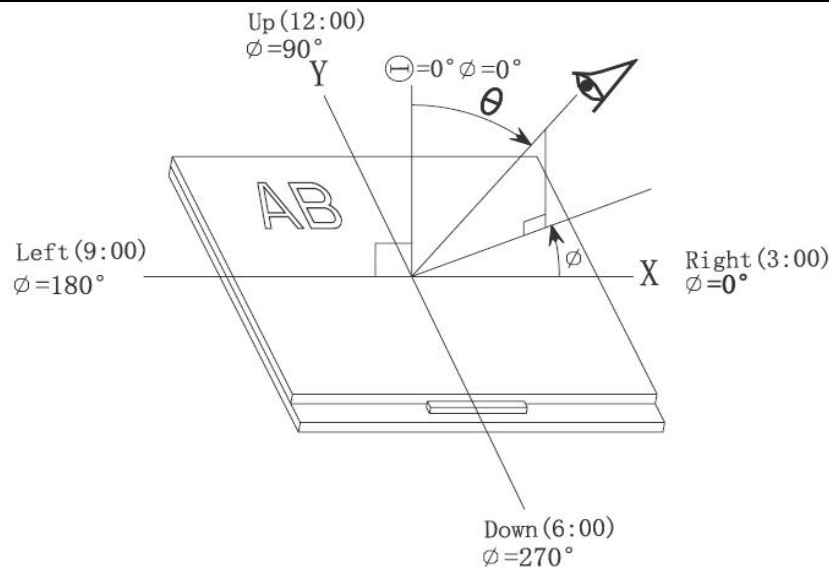

Note 4: Definition of contrast ratio.(Test LCD using DMS501)

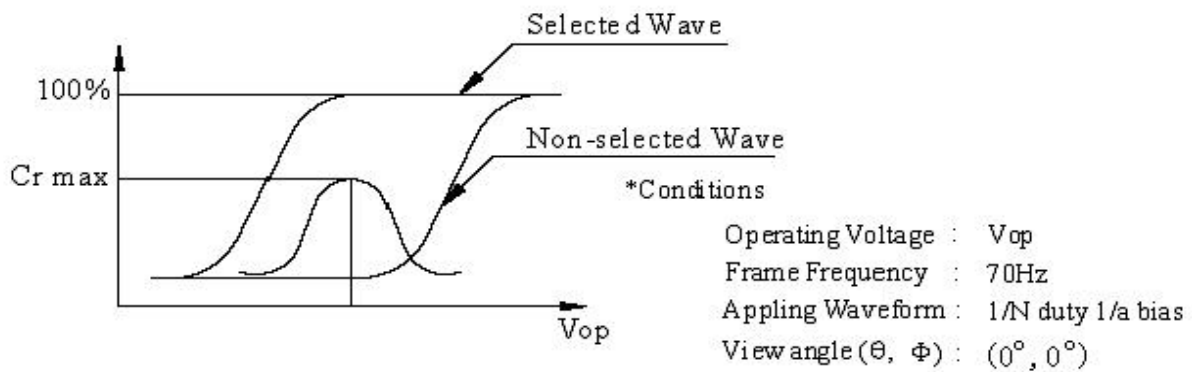

$$\text{Contrast ratio}(Cr) = \frac{\text{Brightness of selected dots}}{\text{Brightness of non-selected dots}}$$

Note 5: Definition of Response time. (Test LCD using DMS501):

The output signals of photo detector are measured when the input signals are changed from “black” to “white”(falling time) and from “white” to “black”(rising time), respectively. The response time is defined as the time interval between the 10% and 90% of amplitudes.Refer to figure as below.

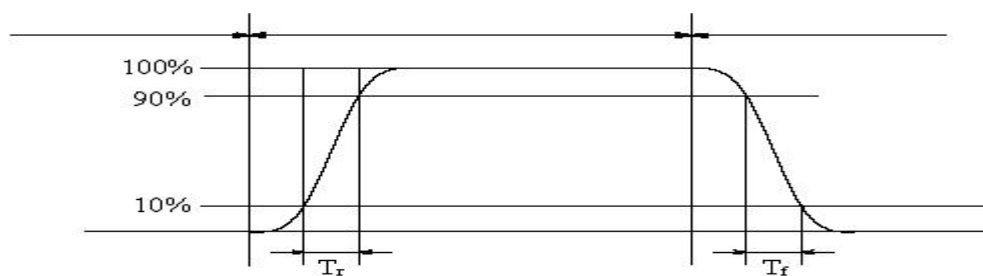

The definition of response time

Note 6: Definition of Color of CIE Coordinate and NTSC Ratio.

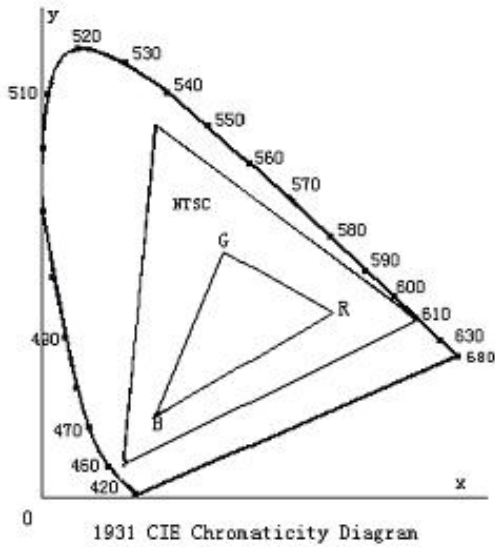

Color gamut:

$$S = \frac{\text{area of RGB triangle}}{\text{area of NTSC triangle}} \times 100\%$$

Note 7: Definition of cross talk.

$$\text{Cross talk ratio(\%)} = \frac{|\text{pattern A Brightness} - \text{pattern B Brightness}|}{\text{pattern A Brightness}} \times 100$$

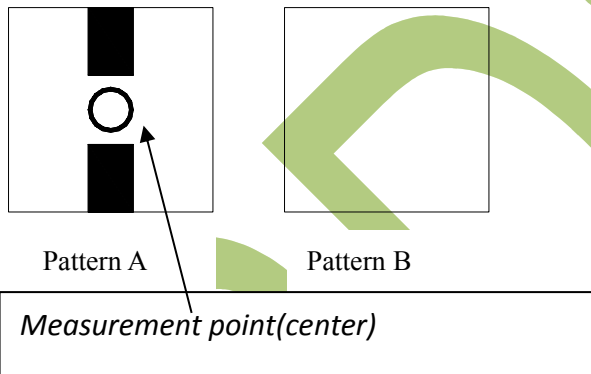

Electric volume value = $3F \pm 3Hex$

8. Reliability Test Items and Criteria

No	Test Item	Test condition	Criterion
1	High Temperature Storage	80°C±2°C 96H Restore 2H at 25°C Power off	1. After testing, cosmetic and electrical defects should not happen. 2. Total current consumption should not be more than twice of initial value.
2	Low Temperature Storage	-30°C±2°C 96H Restore 2H at 25°C Power off	
3	High Temperature Operation	70°C±2°C 96H Restore 2H at 25°C Power on	
4	Low Temperature Operation	-20°C±2°C 96H Restore 4H at 25°C Power on	
5	High Temperature/Humidity Storage	60°C±2°C 90%RH 96H Power off	
6	Temperature Cycle	-30°C —————> 80°C after 5 cycle, Restore 2H at 25°C 30min 5min 30min Power off	
7	Vibration Test	10Hz~150Hz, 100m/s ² , 120min	Not allowed cosmetic and electrical defects.
8	Shock Test	Half- sine wave, 300m/s ² , 11ms	

Note: Operation: Supply 3.3V for logic system.

The inspection terms after reliability test, as below

ITEM	Inspection
Contrast	CR>50%
IDD	IDD<200%
Brightness	Brightness>60%
Color Tone	Color Tone+/-0,05

9. Precautions for Use of LCD Modules

9.1 Handling Precautions

9.1.1 The display panel is made of glass. Do not subject it to a mechanical shock by dropping it from a high place, etc.

9.1.2 If the display panel is damaged and the liquid crystal substance inside it leaks out, be sure not to get any in your mouth, if the substance comes into contact with your skin or clothes, promptly wash it off using soap and water.

9.1.3 Do not apply excessive force to the display surface or the adjoining areas since this may cause the color tone to vary.

9.1.4 The polarizer covering the display surface of the LCD module is soft and easily scratched. Handle this polarizer carefully.

9.1.5 If the display surface is contaminated, breathe on the surface and gently wipe it with a soft dry cloth. If still not completely clear, moisten cloth with one of the following solvents:

- Isopropyl alcohol
- Ethyl alcohol

Solvents other than those mentioned above may damage the polarizer. Especially, do not use the following:

- Water
- Ketone
- Aromatic solvents

9.1.6 Do not attempt to disassemble the LCD Module.

9.1.7 If the logic circuit power is off, do not apply the input signals.

9.1.8 To prevent destruction of the elements by static electricity, be careful to maintain an optimum work environment.

- a. Be sure to ground the body when handling the LCD Modules.
- b. Tools required for assembly, such as soldering irons, must be properly ground.
- c. To reduce the amount of static electricity generated, do not conduct assembly and other work under dry conditions.
- d. The LCD Module is coated with a film to protect the display surface. Be care when peeling off this protective film since static electricity may be generated.

9.2 Storage precautions

9.2.1 When storing the LCD modules, avoid exposure to direct sunlight or to the light of fluorescent lamps.

9.2.2 The LCD modules should be stored under the storage temperature range. If the LCD modules will be stored for a long time, the recommend condition is:

Temperature : $0^{\circ}\text{C} \sim 40^{\circ}\text{C}$

Relatively humidity: $\leq 80\%$

9.2.3 The LCD modules should be stored in the room without acid, alkali and harmful gas.

9.3 The LCD modules should be no falling and violent shocking during transportation, and also should avoid excessive press, water, damp and sunshine.

END



Our company network supports you worldwide with offices in Germany, Austria, Switzerland, the UK and the USA. For more information please contact:

Headquarters

Germany



FORTEC Elektronik AG

Lechwiesenstr. 9
86899 Landsberg am Lech

Phone: +49 8191 91172-0
E-Mail: sales@forteca.de
Internet: www.forteca.de

Fortec Group Members

Austria



FORTEC Elektronik AG

Office Vienna

Nuschinggasse 12
1230 Wien

Phone: +43 1 8673492-0
E-Mail: office@fortec.at
Internet: www.fortec.at

Germany



Distec GmbH

Augsburger Str. 2b
82110 Germering

Phone: +49 89 894363-0
E-Mail: info@distec.de
Internet: www.distec.de

Switzerland



ALTRAC AG

Bahnhofstraße 3
5436 Würenlos

Phone: +41 44 7446111
E-Mail: info@altrac.ch
Internet: www.altrac.ch

United Kingdom



Display Technology Ltd.

Osprey House, 1 Osprey Court
Hichingbrooke Business Park
Huntingdon, Cambridgeshire, PE29 6FN

Phone: +44 1480 411600
E-Mail: info@displaytechnology.co.uk
Internet: www.displaytechnology.co.uk

USA



Apollo Display Technologies, Corp.

87 Raynor Avenue,
Unit 1 Ronkonkoma,
NY 11779

Phone: +1 631 5804360
E-Mail: info@apolloDisplays.com
Internet: www.apolloDisplays.com