



OUR GLOBAL  
COMPETENCE  
CENTRES

 APOLLO DISPLAY  
TECHNOLOGIES



 DISTEC



 DISPLAY  
TECHNOLOGY



# Datasheet

## AUO

**G101EVN03.1**

UP-02-180

The information contained in this document has been carefully researched and is, to the best of our knowledge, accurate. However, we assume no liability for any product failures or damages, immediate or consequential, resulting from the use of the information provided herein. Our products are not intended for use in systems in which failures of product could result in personal injury. All trademarks mentioned herein are property of their respective owners. All specifications are subject to change without notice.

---



# Product Specification

G101EVN03.1

AU OPTRONICS CORPORATION

- (v) Preliminary Specifications
- ( ) Final Specifications

<b>Module</b>	10.1 Inch Color TFT-LCD
<b>Model Name</b>	G101EVN03.1

<table style="width: 100%; border-collapse: collapse;"> <tr> <td style="width: 50%;"><b>Customer</b></td> <td style="width: 50%;"><b>Date</b></td> </tr> <tr> <td style="height: 100px;"> </td> <td> </td> </tr> <tr> <td style="text-align: center;"><b>Checked &amp; Approved by</b></td> <td> </td> </tr> <tr> <td style="border-top: 1px solid black;"> </td> <td style="border-top: 1px solid black;"> </td> </tr> </table>	<b>Customer</b>	<b>Date</b>			<b>Checked &amp; Approved by</b>				<table style="width: 100%; border-collapse: collapse;"> <tr> <td style="width: 50%;"><b>Approved by</b></td> <td style="width: 50%;"><b>Date</b></td> </tr> <tr> <td style="text-align: center; vertical-align: middle;"><u>Grace Hung</u></td> <td> </td> </tr> <tr> <td style="text-align: center;"><b>Prepared by</b></td> <td> </td> </tr> <tr> <td style="text-align: center; vertical-align: middle;"><u>Ken Wang</u></td> <td> </td> </tr> <tr> <td colspan="2" style="text-align: center; padding-top: 20px;">General Display Business Unit / AU Optronics corporation</td> </tr> </table>	<b>Approved by</b>	<b>Date</b>	<u>Grace Hung</u>		<b>Prepared by</b>		<u>Ken Wang</u>		General Display Business Unit / AU Optronics corporation	
<b>Customer</b>	<b>Date</b>																		
<b>Checked &amp; Approved by</b>																			
<b>Approved by</b>	<b>Date</b>																		
<u>Grace Hung</u>																			
<b>Prepared by</b>																			
<u>Ken Wang</u>																			
General Display Business Unit / AU Optronics corporation																			



## Contents

<b>1. Operating Precautions</b> .....	<b>4</b>
<b>2. General Description</b> .....	<b>5</b>
2.1 Display Characteristics .....	5
2.2 Optical Characteristics .....	6
<b>3. Functional Block Diagram</b> .....	<b>9</b>
<b>4. Absolute Maximum Ratings</b> .....	<b>10</b>
4.1 Absolute Ratings of TFT LCD Module.....	10
4.2 Absolute Ratings of Environment.....	10
<b>5. Electrical Characteristics</b> .....	<b>11</b>
5.1 TFT LCD Module .....	11
5.2 Backlight Unit.....	13
<b>6. Signal Characteristic</b> .....	<b>14</b>
6.1 Pixel Format Image.....	14
6.2 Signal Description .....	15
6.3 The Input Data Format.....	17
6.4 Interface Timing .....	18
6.5 Power ON/OFF Sequence .....	19
<b>7. Reliability Test Criteria</b> .....	<b>20</b>
<b>8. Mechanical Characteristics</b> .....	<b>21</b>
8.1 Outline Dimension (Front View) .....	21
8.2 Outline Dimension (Rear View).....	22
<b>9. Label and Packaging</b> .....	<b>23</b>
9.1 Shipping Label .....	23
9.2 Carton/Pallet Package .....	23
<b>10 Safety</b> .....	<b>25</b>
10.1 Sharp Edge Requirements.....	25
10.2 Materials .....	25
10.3 Capacitors.....	25
10.4 National Test Lab Requirement.....	25



# Record of Revision

## Product Specification

AU OPTRONICS CORPORATION

G101EVN03.1

Version and Date	Page	Old description	New Description
0.1 2017/06/15	All	First draft specification	-

AUO Confidential  
 For DISTEC Internal Use Only  
 20180911 11:16:52

AUO Confidential  
 For DISTEC Internal Use Only  
 20180911 11:16:52

AUO Confidential  
 For DISTEC Internal Use Only  
 20180911 11:16:52



## 1. Operating Precautions

- 1) Since front polarizer is easily damaged, please be cautious and not to scratch it.
- 2) Be sure to turn off power supply when inserting or disconnecting from input connector.
- 3) Wipe off water drop immediately. Long contact with water may cause discoloration or spots.
- 4) When the panel surface is soiled, wipe it with absorbent cotton or soft cloth.
- 5) Since the panel is made of glass, it may be broken or cracked if dropped or bumped on hard surface.
- 6) To avoid ESD (Electro Static Discharge) damage, be sure to ground yourself before handling TFT-LCD Module.
- 7) Do not open nor modify the module assembly.
- 8) Do not press the reflector sheet at the back of the module to any direction.
- 9) In case if a module has to be put back into the packing container slot after it was taken out from the container, do not press the center of the LED light bar edge. Instead, press at the far ends of the LED light bar edge softly. Otherwise the TFT Module may be damaged.
- 10) At the insertion or removal of the Signal Interface Connector, be sure not to rotate nor tilt the Interface Connector of the TFT Module.
- 11) TFT-LCD Module is not allowed to be twisted & bent even force is added on module in a very short time. Please design your display product well to avoid external force applying to module by end-user directly.
- 12) Small amount of materials having no flammability grade is used in the LCD module. The LCD module should be supplied by power complied with requirements of Limited Power Source (IEC60950 or UL1950), or be applied exemption.
- 13) Severe temperature condition may result in different luminance, response time and lamp ignition voltage.
- 14) Continuous operating TFT-LCD display under low temperature environment may accelerate lamp exhaustion and reduce luminance dramatically.
- 15) The data on this specification sheet is applicable when LCD module is placed in landscape position.
- 16) Continuous displaying fixed pattern may induce image sticking. It's recommended to use screen saver or shuffle content periodically if fixed pattern is displayed on the screen.
- 17) In order not to damage the touch panel, please remove the protected film as slow as possible in an environment with a humidity range from 60% to 80%



## 2. General Description

G101EVN03.1 is a Color Active Matrix Liquid Crystal Display composed of a TFT LCD panel and LED backlight system. The screen format is intended to support the 16:10 WXGA, 1280(H) x 800(V) screen and 16.2M colors with LED backlight driving circuit. All input signals are LVDS interface compatible.

### 2.1 Display Characteristics

The following items are characteristics summary under 25 °C condition:

Items	Unit	Specifications
Screen Diagonal	[inch]	10.1"
Active Area	[mm]	216.96(H) x 135.6(V)
Pixels H x V		1280 x 800
Pixel Pitch	[mm]	0.1695 X 0.1695
Pixel Arrangement		R.G.B. Vertical Stripe
Display Mode		MVA, Normally Black
Nominal Input Voltage VDD	[Volt]	3.3 (Typical)
Power Consumption (Max)	[Watt]	Logic: 0.89W Backlight: 7.4W (For reference)
Weight (Max.)	[Grams]	350g
Physical Size (Max.)	[mm]	227.69 x 148.31 x 7.75 (PCBA side)
Electrical Interface		LVDS
Surface Treatment		Glare
Support Color		262K (6bits)/16.2M (8bits) colors
Temperature Range Operating Storage (Non-Operating)	[°C] [°C]	-20 to +60 -30 to +70
RoHS Compliance		RoHS Compliance

## 2.2 Optical Characteristics

The optical characteristics are measured under stable conditions at 25 °C (Room Temperature):

Item	Unit	Conditions	Min.	Typ.	Max.	Note
White Luminance	[cd/m <sup>2</sup> ]	I <sub>LED</sub> = 70mA (5p average)	800	1000	---	
Uniformity	%	5 points	70%		---	
Contrast Ratio			1000	1300	---	
Response Time	[msec]	Rising + Falling	---	25	35	
Viewing Angle	[degree]	Horizontal (Right) CR = 10 (Left)	80	85	---	
	[degree]		80	85	---	
	[degree]	Vertical (Upper) CR = 10 (Lower)	80	85	---	
	[degree]		80	85	---	
Color / Chromaticity Coordinates (CIE 1931)		Red x	0.513	0.563	0.613	
		Red y	0.278	0.328	0.378	
		Green x	0.281	0.331	0.381	
		Green y	0.527	0.577	0.627	
		Blue x	0.109	0.159	0.209	
		Blue y	0.083	0.133	0.183	
		White x	0.263	0.313	0.363	
		White y	0.279	0.329	0.379	
Color Gamut	%		---	45	---	

Note 1: Measurement method

Equipment Pattern Generator, Power Supply, Digital Voltmeter, Luminance meter (SR\_3 or equivalent)

Aperture Field angle 2° with 50cm measuring distance

Test Point Follow Note 2 position

Environment < 1 lux

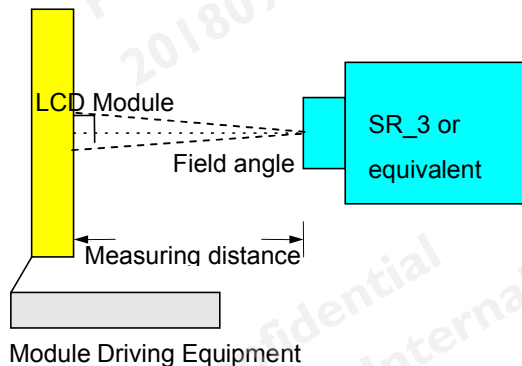



Note 2: Definition of 5 points position

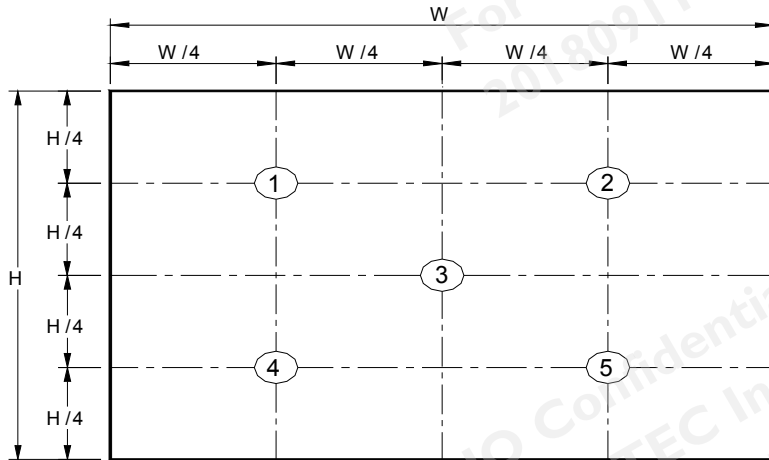

Note 3: The luminance uniformity of 5 points is defined by dividing the minimum luminance values by the maximum test point luminance

$$\delta_{w5} = \frac{\text{Minimum Brightness of five points}}{\text{Maximum Brightness of five points}}$$

Note 4: Definition of contrast ratio (CR):

$$\text{Contrast ratio (CR)} = \frac{\text{Brightness on the "White" state}}{\text{Brightness on the "Black" state}}$$

Note 5: Definition of response time:

The output signals of photo detector are measured when the input signals are changed from "White" to "Black" (falling time) and from "Black" to "White" (rising time), respectively. The response time interval is between 10% and 90% of amplitudes. Please refer to the figure as below.

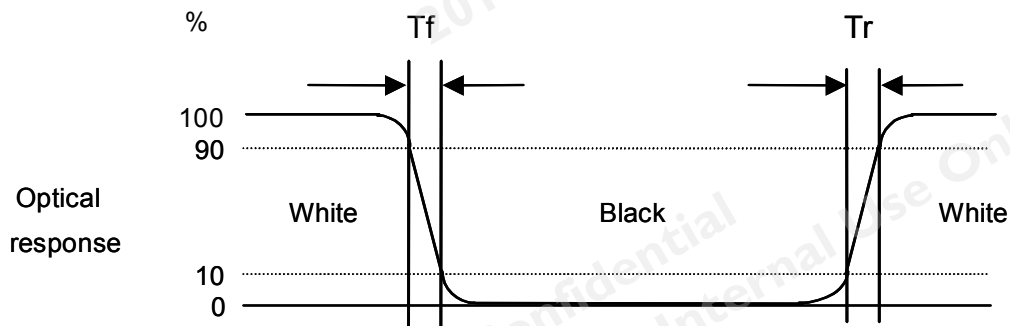

Note 6: Definition of viewing angle

Viewing angle is the measurement of contrast ratio  $\geq 10$ , at the screen center, over a 180° horizontal and 180° vertical range (off-normal viewing angles). The 180° viewing angle range is broken down as below: 90° ( $\theta$ ) horizontal left and right, and 90° ( $\Phi$ ) vertical high (up) and low (down). The measurement direction is typically perpendicular to the display surface with the screen rotated to its center to develop the desired measurement viewing angle.

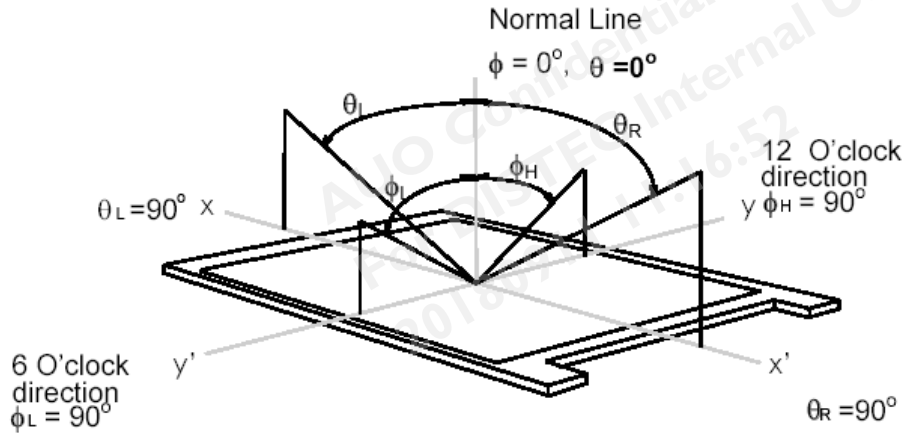

## 3. Functional Block Diagram

The following diagram shows the functional block of the 10.1 inch color TFT/LCD module:

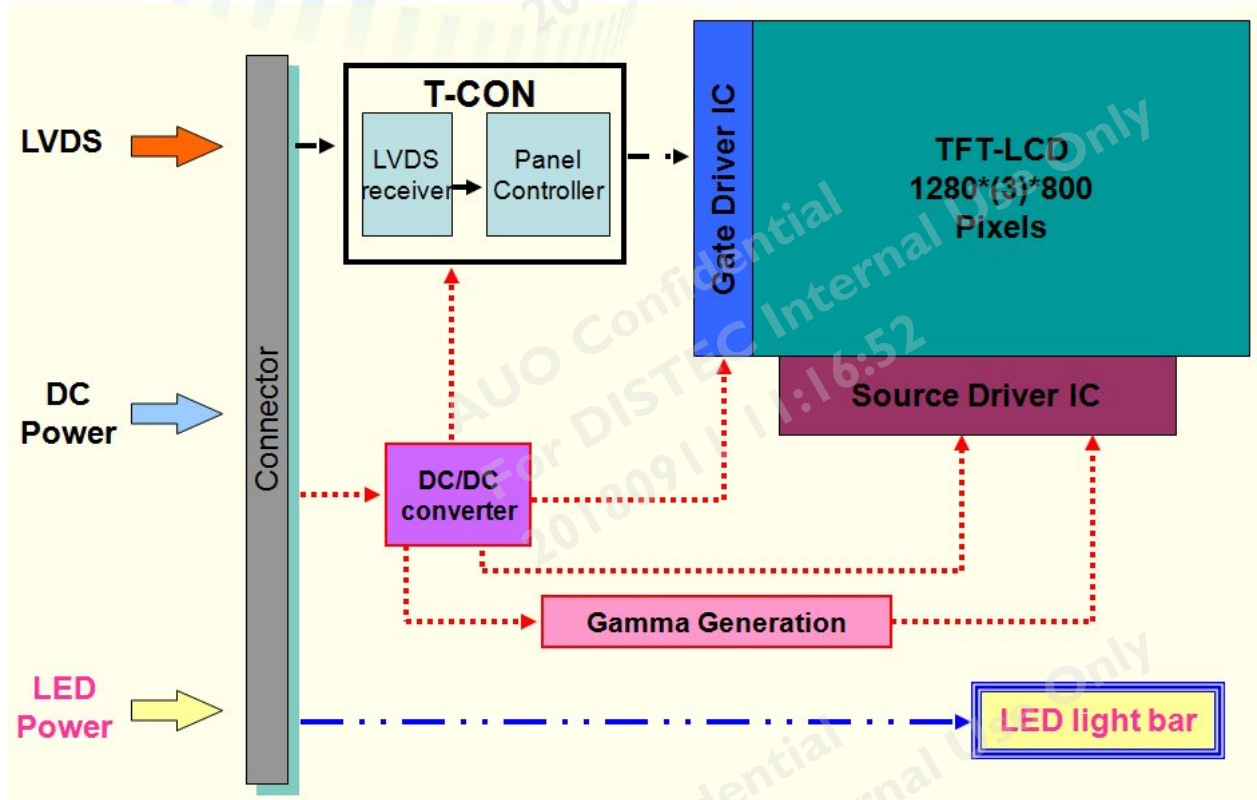

## 4. Absolute Maximum Ratings

### 4.1 Absolute Ratings of TFT LCD Module

Item	Symbol	Min	Max	Unit
Logic/LCD drive Voltage	VDD	-0.3	+4.0	[Volt]
LCD Input Signal Voltage	V <sub>SIGNAL</sub>	-0.3	VDD+0.3	[Volt]

### 4.2 Absolute Ratings of Environment

Item	Symbol	Min	Max	Unit
Operating Temperature	TOP	-20	+60	[°C]
Humidity	HOP	5	90	[%RH]
Storage Temperature	TST	-30	+70	[°C]

Note 1: Permanent damage to the device may occur if exceed maximum values

Note 2: Maximum wet-bulb temperature is less than 39°C and no condensation

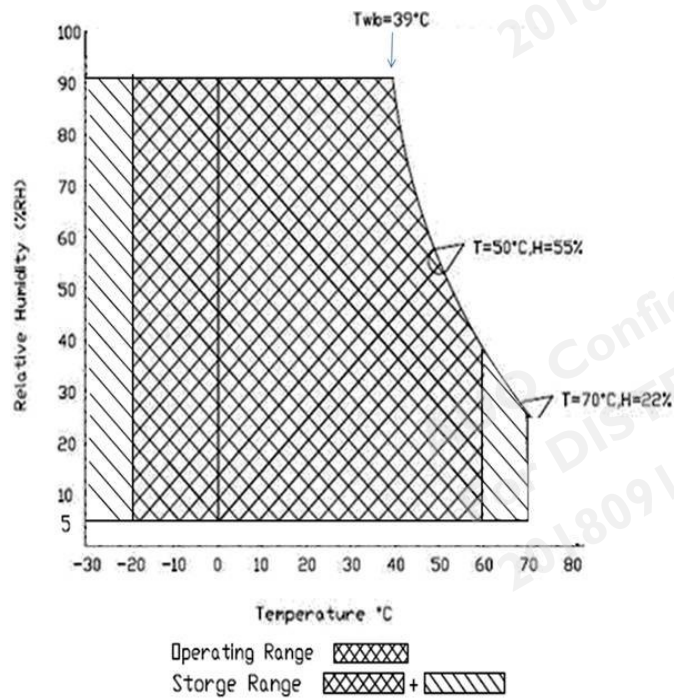

## 5. Electrical Characteristics

### 5.1 TFT LCD Module

#### 5.1.1 Power Specification

The power specification are measured under 25°C and frame frequency under 60Hz

Symbol	Parameter	Min	Typ	Max	Units	Remark
VDD	Logic/LCD Drive Voltage	3.0	3.3	3.6	[Volt]	
IDD	VDD Current	-	192	270	[mA]	All Black Pattern (VDD=3.3V, at 60Hz)
Irush	LCD Inrush Current	-	-	1500	[mA]	Note 1
PDD	VDD Power	-	0.63	0.89	[Watt]	All Black Pattern (VDD=3.3V, at 60Hz)
VDDrp	Allowable Logic/LCD Drive Ripple Voltage	-	-	100	[mV] p-p	All Black Pattern (VDD=3.3V, at 60Hz)

Note 1 : Maximum Measurement Condition : White Pattern at 3.3V driving voltage. ( $P_{max} = V_{3.3} \times I_{white}$ )

Note 2 : Measure Condition

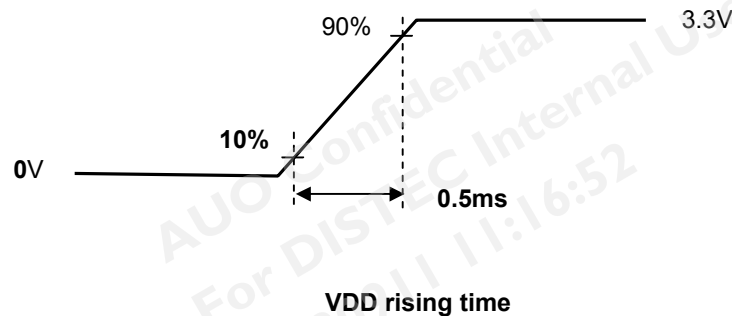

## 5.1.2 Signal Electrical Characteristics

Input signals shall be low or Hi-Z state when VDD is off.

Signal electrical characteristics are as follows;

Symbol	Item	Min.	Typ.	Max.	Unit	Remark
V <sub>TH</sub>	Differential Input High Threshold	---		100	[mV]	V <sub>CM</sub> =1.2V
V <sub>TL</sub>	Differential Input Low Threshold	-100		----	[mV]	V <sub>CM</sub> =1.2V
V <sub>ID</sub>	Input Differential Voltage	100		600	[mV]	
V <sub>ICM</sub>	Differential Input Common Mode Voltage	0.7		1.6	[V]	V <sub>TH</sub> /V <sub>TL</sub> =+-100mV

Note: LVDS Signal Waveform.

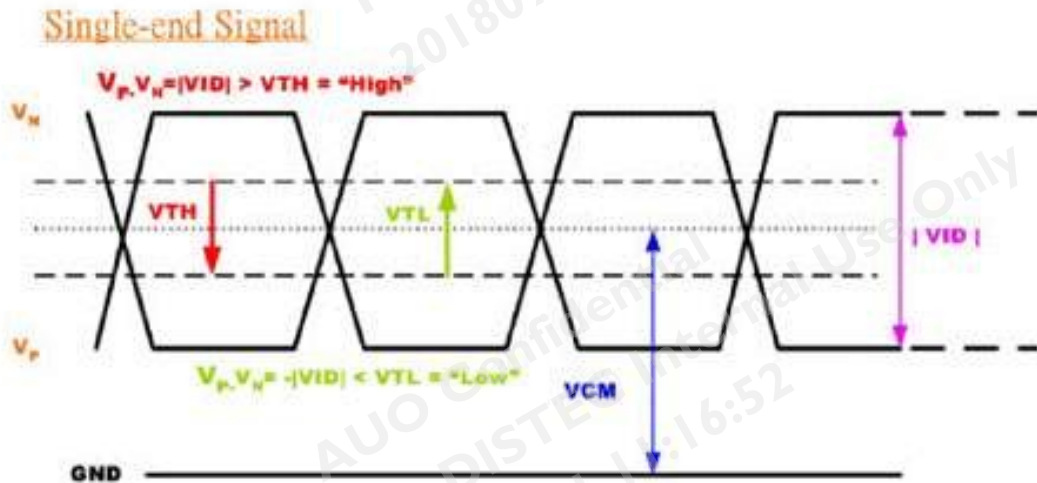



## 5.2 Backlight Unit

### 5.2.1 Parameter guideline for LED

Following characteristics are measured under a stable condition using an inverter at 25°C (Room Temperature):

Symbol	Parameter	Min.	Typ.	Max.	Unit	Remark
$V_{LED}$	Input Voltage	25.2	28.8	32.4	[Volt]	Note 2
$I_F$	LED Forward Current	---	70	---	[mA]	Ta = 25°C
Operation Life	---	50,000	---	---	Hrs	$I_F=70mA$ (Ta=25°C)

Note 1: Ta means ambient temperature of TFT-LCD module.

Note 2:  $V_{LED}$  typical value is defined for LED backlight (100% duty of PWM dimming)

Note 3: If G101EVN03.1 module is driven by high current or at high ambient temperature & humidity condition. The operating life will be reduced.

Note 4: Operating life means brightness goes down to 50% initial brightness. Minimum operating life time is estimated data.

## 6. Signal Characteristic

### 6.1 Pixel Format Image

Following figure shows the relationship between input signal and LCD pixel format.

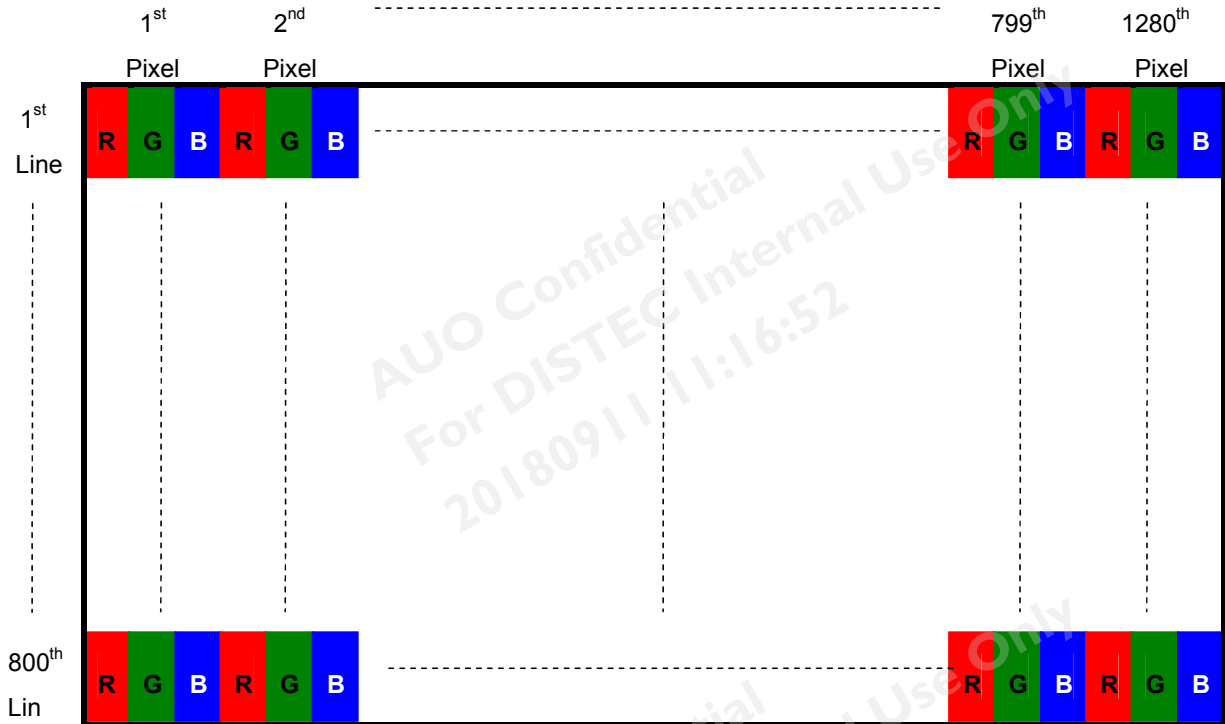



## 6.2 Signal Description

The module uses a LVDS receiver embedded in AUO's ASIC. LVDS is a differential signal technology for LCD interface and a high-speed data transfer device.

### 6.2.1 LVDS Connector Description

Physical interface is described as for the connector on module.

These connectors are capable of accommodating the following signals and will be following components.

Connector Name / Designation	For Signal Connector
Manufacturer	JAE or compatible
Type	HD1S040HA1 or compatible

### 6.2.2 LVDS Pin Assignment

LVDS is a differential signal technology for LCD interface and high speed data transfer device.

Pin No	Symbol	Function
1	NC	No Connection (Reserved)
2	VDD	Power Supply +3.3V
3	VDD	Power Supply +3.3V
4	VDD	Power Supply +3.3V
5	NC	No Connection (Reserved)
6	NC	No Connection (Reserved)
7	NC	No Connection (Reserved)
8	Rin0-	-LVDS differential data input(R0-R5,G0)
9	Rin0+	+LVDS differential data input(R0-R5,G0)
10	GND	Ground
11	Rin1-	-LVDS differential data input(G1-G5,B0-B1)
12	Rin1+	+LVDS differential data input(G1-G5,B0-B1)
13	GND	Ground
14	Rin2-	-LVDS differential data input(B2-B5,DE)
15	Rin2+	+LVDS differential data input(B2-B5,DE)
16	GND	Ground
17	ClkIN-	-LVDS differential clock input
18	ClkIN+	+LVDS differential clock input
19	GND	Ground-Shield
20	Rin3-	-LVDS differential data input(R6-R7,G6-G7,B6-B7)
21	Rin3+	+LVDS differential data input(R6-R7,G6-G7,B6-B7)
22	GND	Ground-Shield
23	SEL68	Selection for either 6bit or 8bit LVDS input: SEL68 = " High" or "NC", accepts 6bit LVDS data input; SEL68 = " Low", accepts 8bit LVDS data input.

24	NC	No Connection (Reserved)
25	VOUT	Positive voltage to connection LED BLU
26	VOUT	Positive voltage to connection LED BLU
27	VOUT	Positive voltage to connection LED BLU
28	NC	No Connection (Reserved)
29	LB3	Constant current feedback signal 3
30	LB3	Constant current feedback signal 3
31	LB3	Constant current feedback signal 3
32	LB2	Constant current feedback signal 2
33	LB2	Constant current feedback signal 2
34	LB2	Constant current feedback signal 2
35	LB1	Constant current feedback signal 1
36	LB1	Constant current feedback signal 1
37	LB1	Constant current feedback signal 1
38	NC	No Connection (Reserved)
39	GND	Ground
40	GND	Ground

Note 1: Input signals shall be low or High-impedance state when VDD is off.

Note 2: High stands for "3.3V", Low stands for "0V", NC means "No Connection".

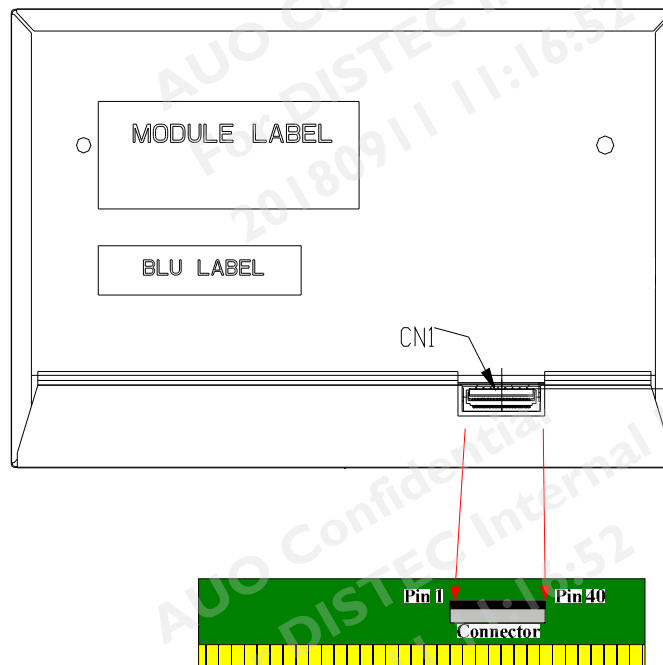

## 6.3 The Input Data Format

**SEL68 = "H" or NC for 6 bits LVDS Input**

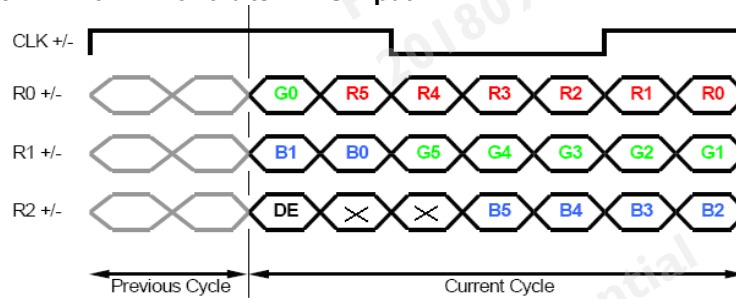

**SEL68 ="L" for 8 bits LVDS Input**

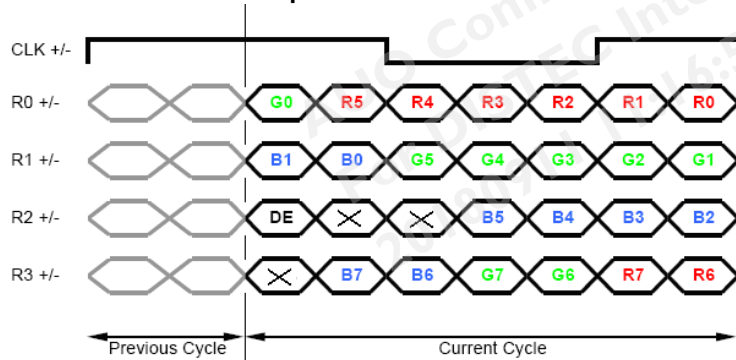

Signal Name	Description	
R7 R6 R5 R4 R3 R2 R1 R0	Red Data 7 (MSB) Red Data 6 Red Data 5 Red Data 4 Red Data 3 Red Data 2 Red Data 1 Red Data 0 (LSB)	Red-pixel Data  For 8Bits LVDS input MSB: R7 ; LSB: R0  For 6Bits LVDS input MSB: R5 ; LSB: R0
G7 G6 G5 G4 G3 G2 G1 G0	Green Data 7 (MSB) Green Data 6 Green Data 5 Green Data 4 Green Data 3 Green Data 2 Green Data 1 Green Data 0 (LSB)	Green-pixel Data  For 8Bits LVDS input MSB: R7 ; LSB: R0  For 6Bits LVDS input MSB: R5 ; LSB: R0
B7 B6 B5 B4 B3 B2 B1 B0	Blue Data 7 (MSB) Blue Data 6 Blue Data 5 Blue Data 4 Blue Data 3 Blue Data 2 Blue Data 1 Blue Data 0 (LSB)	Blue-pixel Data  For 8Bits LVDS input MSB: R7 ; LSB: R0  For 6Bits LVDS input MSB: R5 ; LSB: R0
RxCLKIN	Data Clock	The signal is used to strobe the pixel data and DE signals. All pixel data shall be valid at the falling edge when the DE signal is high.
DE	Display Timing	This signal is strobed at the falling edge of RxCLKIN. When the signal is high, the pixel data shall be valid to be displayed.

Note: Output signals from any system shall be low or High-impedance state when VDD is off.

## 6.4 Interface Timing

### 6.4.1 Timing Characteristics

Signal	Symbol	Min.	Typ.	Max.	Unit	
Clock Frequency	$1/T_{\text{Clock}}$	64	68.93	85	MHz	
Vertical Section	Period	$T_V$	808	816	1023	$T_{\text{Line}}$
	Active	$T_{VD}$	800			
	Blanking	$T_{VB}$	8	16	223	
Horizontal Section	Period	$T_H$	1330	1408	2047	$T_{\text{Clock}}$
	Active	$T_{HD}$	1280			
	Blanking	$T_{HB}$	50	128	767	
Frame Rate	F	---	60	---	Hz	

Note : DE mode.

### 6.4.2 Input Timing Diagram

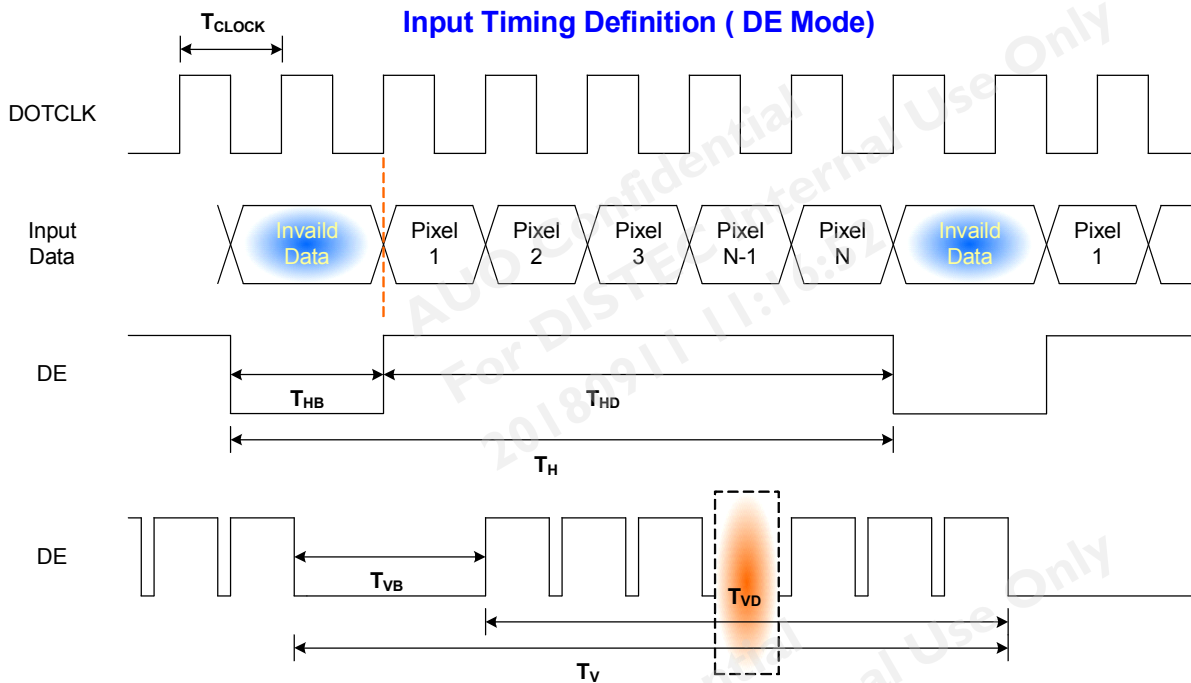

## 6.5 Power ON/OFF Sequence

VDD power and lamp on/off sequence is as below. Interface signals are also shown in the chart. Signals from any system shall be Hi-Z state or low level when VDD is off.

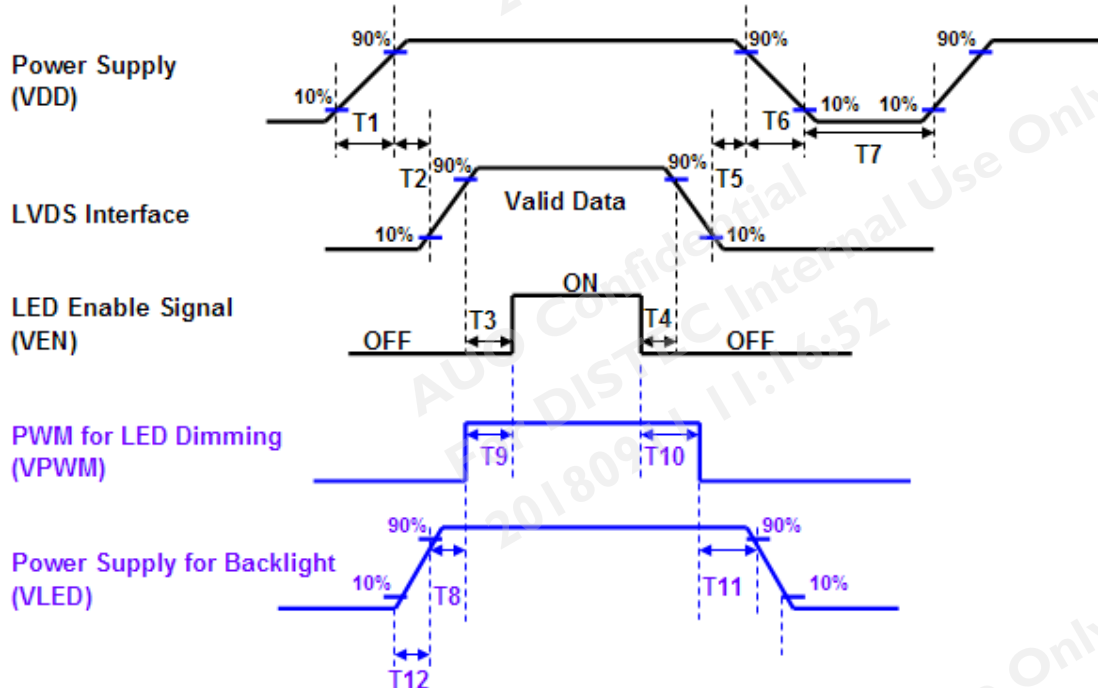

**Power ON/OFF sequence timing**

Parameter	Value			Units
	Min.	Typ.	Max.	
T1	0.5		10	[ms]
T2	0		50	[ms]
T3	200		-	[ms]
T4	200		-	[ms]
T5	0		50	[ms]
T6	0		10	[ms]
T7	500		-	[ms]
T8	10		-	[ms]
T9	0		180	[ms]
T10	0		180	[ms]
T11	10		-	[ms]
T12	0.5		10	[ms]

The above on/off sequence should be applied to avoid abnormal function in the display. Please make sure to turn off the power when you plug the cable into the input connector or pull the cable out of the connector.

## 7. Reliability Test Criteria

Items	Required Condition	Note
Temperature Humidity Bias	40 °C /90%,300Hr	
High Temperature Operation	60 °C, 300Hr (center point of panel surface)	
Low Temperature Operation	-20 °C, 300Hr	
Hot Storage	70 °C, 300Hr	
Cold Storage	-30 °C, 300Hr	
Thermal Shock Test	-30 °C /30 min , 70 °C /30 min , 20cycles	
Hot Start Test	70 °C /1 Hr min. power on/off per 5 minutes, 5 times	
Cold Start Test	-20 °C /1 Hr min. power on/off per 5 minutes, 5 times	
On/off test	On/10 sec, Off/10 sec, 30,000 cycles	
ESD	Contact : ± 8KV/ operation, Class B Air : ± 15KV / operation, Class B	Note 1
Shock test	220G,2ms, Half-sine wave, 1 times for each direction ( ±X, ±Y, ±Z), non-operation	
Vibration test	1.5G, (10~500Hz, random), 30 mins / axis (X, Y, Z), non-operation	

Note1: According to EN61000-4-2 , ESD class B: Some performance degradation allowed. No data lost  
 . Self-recoverable. No hardware failures.

Note2:

- Water condensation is not allowed for each test items.
- Each test is done by new TFT-LCD module. Don't use the same TFT-LCD module repeatedly for reliability test.
- The reliability test is performed only to examine the TFT-LCD module capability.
- To inspect TFT-LCD module after reliability test, please store it at room temperature and room humidity for 24 hours at least in advance.



### 8. Mechanical Characteristics

#### 8.1 Outline Dimension (Front View)

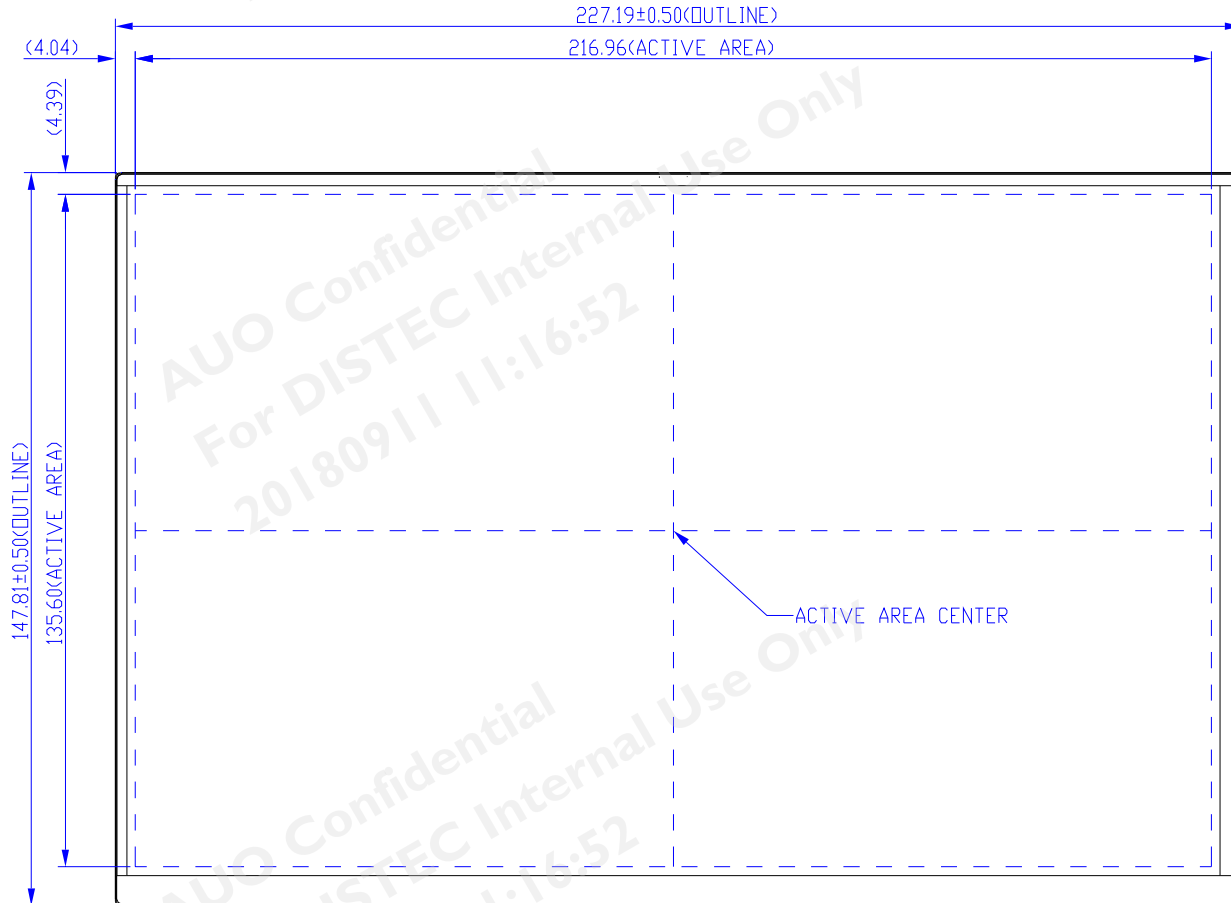



# Product Specification

AU OPTRONICS CORPORATION

G101EVN03.1

## 8.2 Outline Dimension (Rear View)

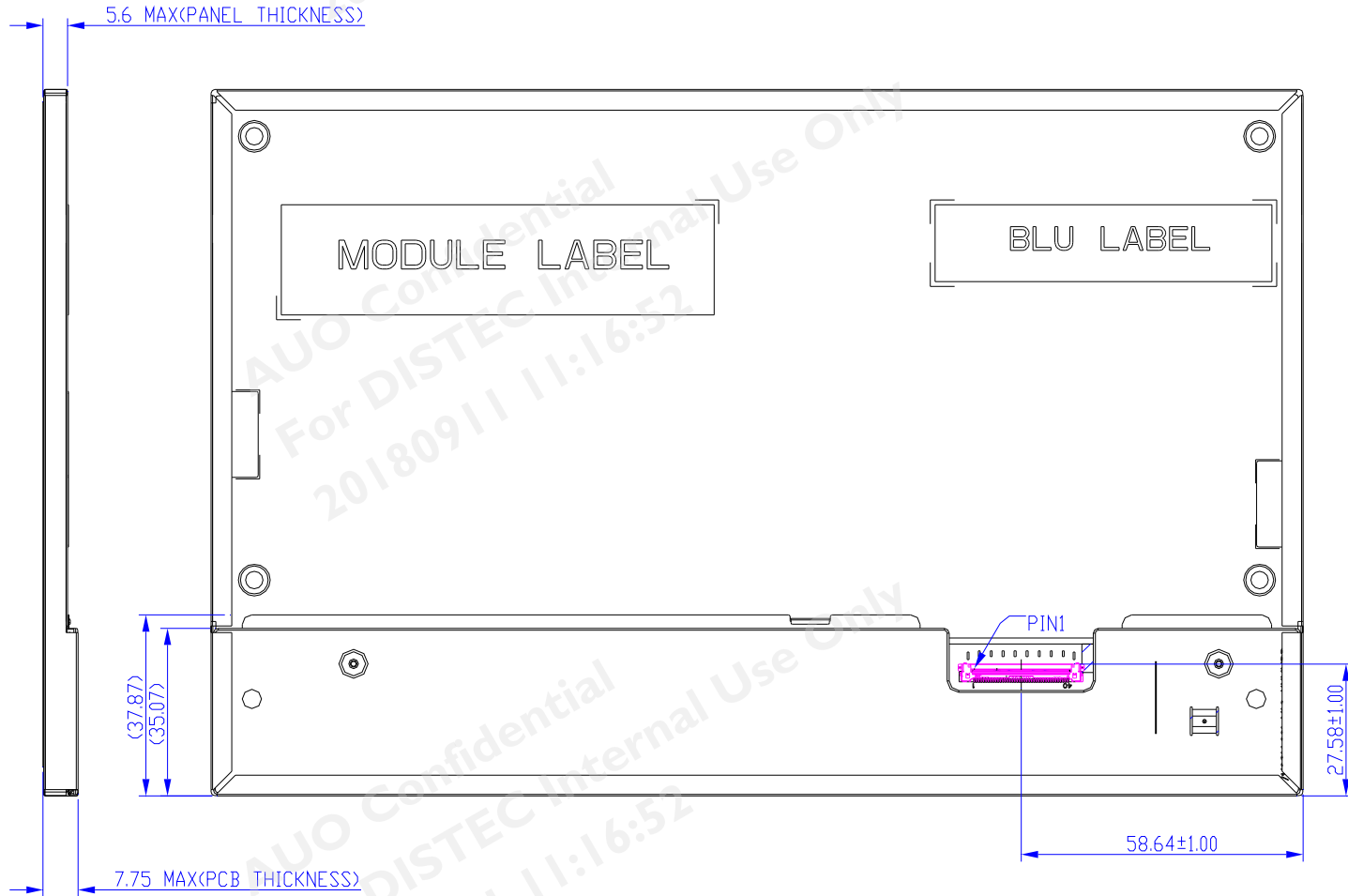



## 9. Label and Packaging

### 9.1 Shipping Label

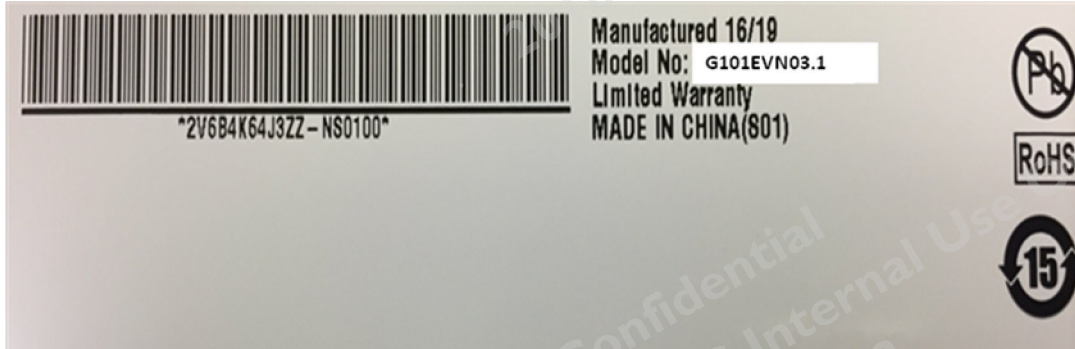

### 9.2 Carton/Pallet Package

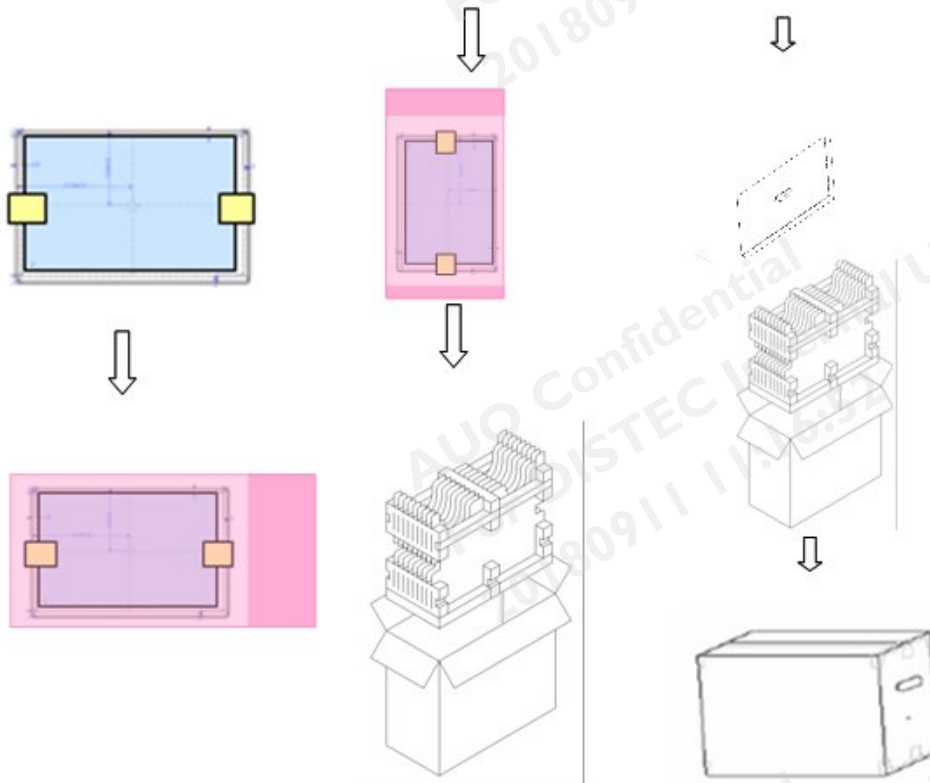

	SHIPPING BY AIR	SHIPPING BY SEA	SHIPPING BY SEA_HQ
MODULE/CARTON	44	44	44
CARTON/LAYER	6	6	6
LAYER/PALLET	4	4+1	4+2
MODULE/PALLET	1056	1320	1584
CARTON SIZE(MM)	450(L)*375(W)*320(H)	450(L)*375(W)*320(H)	450(L)*375(W)*320(H)
PALLET SIZE(MM)	1150(L)*910(W)*132(H)	1150(L)*910(W)*132(H)	1150(L)*910(W)*132(H)
TOTAL PALLET HEIGHT(MM)	1412	1864	2184
TOTAL PALLET WEIGHT(KG)	298	372	446

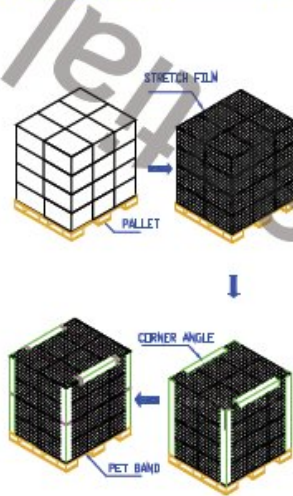

ONE PALLET SHIPMENT EXAMPLE  
SHIPPING BY AIR USED

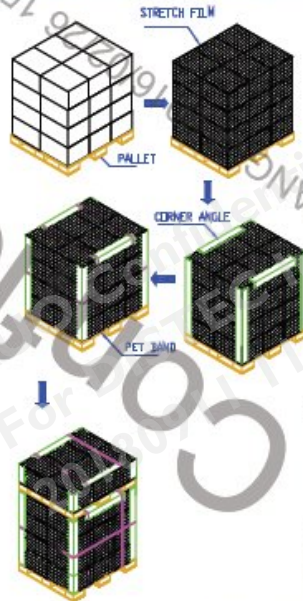

TWO PALLET SHIPMENT EXAMPLE  
SHIPPING BY SFA USFD

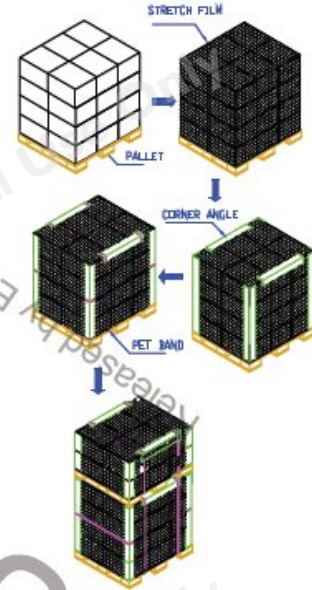

TWO PALLET SHIPMENT EXAMPLE  
SHIPPING BY SEA\_HQ USED



## 10 Safety

### 10.1 Sharp Edge Requirements

There will be no sharp edges or comers on the display assembly that could cause injury.

### 10.2 Materials

#### 10.2.1 Toxicity

There will be no carcinogenic materials used anywhere in the display module. If toxic materials are used, they will be reviewed and approved by the responsible AUO toxicologist.

#### 10.2.2 Flammability

All components including electrical components that do not meet the flammability grade UL94-V1 in the module will complete the flammability rating exception approval process.

The printed circuit board will be made from material rated 94-V1 or better. The actual UL flammability rating will be printed on the printed circuit board.

### 10.3 Capacitors

If any polarized capacitors are used in the display assembly, provisions will be made to keep them from being inserted backwards.

### 10.4 National Test Lab Requirement

The display module will satisfy all requirements for compliance to:

UL 60950-1 second edition

U.S.A. Information Technology Equipment

Our company network supports you worldwide with offices in Germany, Austria, Switzerland, the UK and the USA. For more information please contact:

## Headquarters

### Germany



**FORTEC Elektronik AG**  
Lechwiesenstr. 9  
86899 Landsberg am Lech

Phone: +49 8191 91172-0  
E-Mail: [sales@forteca.de](mailto:sales@forteca.de)  
Internet: [www.forteca.de](http://www.forteca.de)

## Fortec Group Members

### Austria



**FORTEC Elektronik AG**  
**Office Vienna**

Nuschinggasse 12  
1230 Wien

Phone: +43 1 8673492-0  
E-Mail: [office@fortec.at](mailto:office@fortec.at)  
Internet: [www.fortec.at](http://www.fortec.at)

### Germany



**Distec GmbH**

Augsburger Str. 2b  
82110 Germering

Phone: +49 89 894363-0  
E-Mail: [info@distec.de](mailto:info@distec.de)  
Internet: [www.distec.de](http://www.distec.de)

### Switzerland



**ALTRAC AG**

Bahnhofstraße 3  
5436 Würenlos

Phone: +41 44 7446111  
E-Mail: [info@altrac.ch](mailto:info@altrac.ch)  
Internet: [www.altrac.ch](http://www.altrac.ch)

### United Kingdom



**Display Technology Ltd.**

Osprey House, 1 Osprey Court  
Hichingbrooke Business Park  
Huntingdon, Cambridgeshire, PE29 6FN

Phone: +44 1480 411600  
E-Mail: [info@displaytechnology.co.uk](mailto:info@displaytechnology.co.uk)  
Internet: [www.displaytechnology.co.uk](http://www.displaytechnology.co.uk)

### USA



**Apollo Display Technologies, Corp.**

87 Raynor Avenue,  
Unit 1 Ronkonkoma,  
NY 11779

Phone: +1 631 5804360  
E-Mail: [info@apolloDisplays.com](mailto:info@apolloDisplays.com)  
Internet: [www.apolloDisplays.com](http://www.apolloDisplays.com)