

---

# Datasheet

## **ADVANTECH**

**ARK-1124H**

**ARK-1124U**

**ARK-1124C**

The information contained in this document has been carefully researched and is, to the best of our knowledge, accurate. However, we assume no liability for any product failures or damages, immediate or consequential, resulting from the use of the information provided herein. Our products are not intended for use in systems in which failures of product could result in personal injury. All trademarks mentioned herein are property of their respective owners. All specifications are subject to change without notice.

---

# ARK-1124C

## Intel Celeron N3350 DC SoC With Four Serial Ports Modular Fanless Box PC

**NEW**



### Features

- Intel Celeron N3350 Dual Core SoC
- VGA Display, 4 x RS-232/422/485, 2 x USB3.0
- 1 x full-size miniPCIe for communication module
- 1 x 2.5" SATA III SSD/HDD and 1 x half-size mSATA
- -20 ~ 60 °C extended operating temperature
- 12V lockable DC jack power input
- Optional 12~24V power module (Dual Layer)
- Advantech iDoor module compatible (Dual Layer)
- Advantech WISE-PaaS/RMM support



WISE-PaaS/RMM



### Specifications

		ARK-1124C-S1A1E
Processor System	CPU	Intel® Celeron® N3350 Dual Core SoC
	Frequency	1.1 GHz, turbo burst 2.4 GHz
	L2 Cache	2 MB
	BIOS	AMI EFI 64 bit
Memory	Technology	DDR3L 1866 MHz
	Max. Capacity	8 GB
	Socket	1 x 204-pin SO-DIMM
Graphics	Chipset	Intel® HD Graphics 500
	Graphic Engine	4K Codec Decode& Encode for H.264, MPEG2, MVC, VC-1, WMV9, H.265 / HEVC, VP8, JPEG / MJPEG
	VGA	Up to 2048 x 1280 @ 60Hz
Ethernet	LAN	10/100/1000 Mbps Intel i210 GbE, support Wake On Lan
Audio	Interface	Realtek ALC888S, High Definition Audio. Line-out, Line-in
IO Interface	Serial Ports	4 x RS-232/422/485 port with auto flow control
	USB Interface	2 x USB 3.0
Other	Watchdog timer	255 levels timer interval, setup by software
Expansion	Mini PCIe	1 x full-size mPCIe for WLAN/WWAN
	iDoor	1, optional (2nd layer)
Storage	SSD/HDD	Supports 1 x 2.5" SATA III Drive Bay (Compatible with 9.5mm height)
	mSATA	1x Half-size mSATA (by CTOS or T-PN)
Software Support	Microsoft Windows	Win 10 IoT Enterprise LTSB
	Linux	Support by project
Power Requirement	Power Type	AT/ATX
	Power Input Voltage	12V <sub>DC</sub> (Optional 12~24V power module)
	Minimum Power Input	12 V, 3 A
Power Consumption	Power Adapter	AC to DC, DC12 V/3 A, 36 W with lockable DC Jack
	Typical	5.5W
Mechanical	Max.	18.8W
	Construction	Aluminum housing
	Mounting	DIN-Rail/Wall/VESA Mounting Kits (Optional)
	Dimensions (W x H x D)	133 x 46.4 x 94.2mm (5.24" x 1.83" x 3.71")
Environment	Weight	0.7 Kg (1.55lb)
	Operating Temperature	With extended temperature peripherals: -20 ~ 60 °C (-4 ~ 140 °F) with 0.7m/s air flow With 2.5-inch hard disk 0 ~ 40 °C (32 ~ 104 °F) with 0.7m/s air flow
	Storage Temperature	- 40 ~ 85 °C (-40 ~ 185 °F)
	Relative Humidity	95% @ 40 °C (non-condensing)
	Vibration During Operation	With SSD: 3 Grms, IEC 60068-2-64, random, 5 ~ 500 Hz, 1 hr/axis. With HDD: 0.5Grms, IEC 60068-2-64, random, 5~500Hz, 1hr/axis
	Shock During Operation	With SSD: 30 G, IEC 60068-2-27, half sine, 11 ms duration With HDD: 10G, IEC 60068-2-27, half sine, 11 ms duration
	EMC	CE/FCC Class B, CCC, BSMI
	Safety Certifications	UL, CB, CCC, BSMI

## Dimensions

Unit: mm

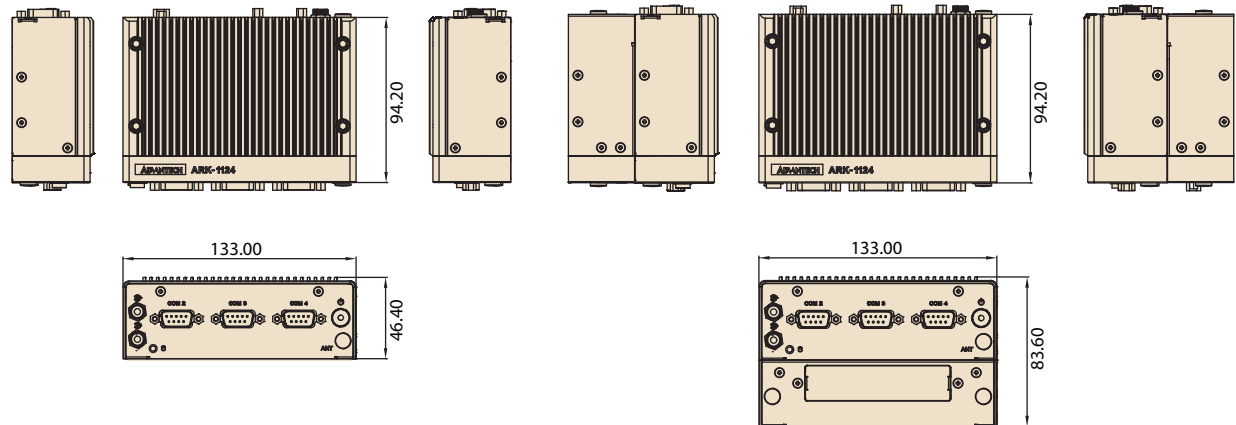

### Front Panel External I/O Mechanical Layout/Drawing

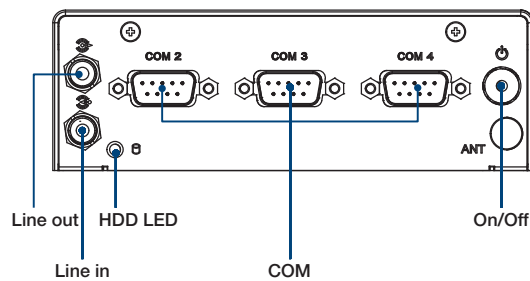

### Rear Panel External I/O Mechanical Layout/Drawing

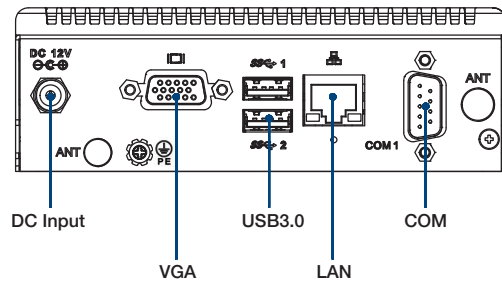

## Ordering Information

Part No.	CPU	RAM	VGA	GbE	USB 3.0	RS-232/422/485	Audio	Full-size MiniPCIe	mSATA	2.5" SATA III HDD Bay	Power Input	Operating Temp.
ARK-1124C-S1A1E	Intel Atom N3350 1.1 GHz SoC	Up to 8GB	1	1	2	4	Lin-out, Line-in	1	1 (H/S)	1	12 V <sub>DC</sub>	-20 ~ 60 °C

Note: Memory, storage and operating system bundled by request.

## Packing List

Part Number	Description
-	1 x ARK-1124C Unit
-	1 x User Manual (Simplified Chinese)
96PSA-A36W12W7	A/D 100-240V 36W 12V C6 LOCKABLE DC PLUG
-	LAN clip
-	Wrench for top cover

## Optional Item for Default SKU

Part Number	Description
1700001524	Power Cable 3-pin 180cm, USA type
170203183C	Power Cable 3-pin 180cm, Europe type
170203180A	Power Cable 3-pin 180cm, UK type
AMK-W001E	ARK-112X series Wall mounting kit
AMK-V003E	ARK-112X series VESA mounting kit
AMK-R001E	ARK-112X series DIN-rail mounting kit

## Optional Embedded OS

Part Number	Description
2070015307	Win10 IoT Ent LTSB 2016 64bit ENG

# ARK-1124U

## Intel Celeron N3350 DC SoC With Dual LAN/ Four USB 3.0/M.2/TPM IoT Gateway Modular Fanless Box PC

**NEW**



### Features

- Intel Celeron N3350 Dual Core SoC
- VGA Display/2x RS-232/422/485/4x USB 3.0
- 1 x Full-size miniPCIe with SIM holder for communication module
- 1 x M.2 E-key for WIFI module
- 20 ~ 60 °C extended operating temperature
- TPM 2.0 default built-in
- 12V lockable DC jack power input
- Optional 12~24V power module (Dual Layer)
- Advantech iDoor module compatible (Dual Layer)
- Advantech WISE-PaaS/RMM support



WISE-PaaS/RMM



### Specifications

		ARK-1124U-S1A1E
Processor System	CPU	Intel® Celeron® N3350 Dual Core SoC
	Frequency	1.1GHz, turbo burst 2.4 GHz
	L2 Cache	2 MB
	BIOS	AMI EFI 64 bit
Memory	Technology	DDR3L 1866 MHz
	Max. Capacity	8 GB
	Socket	1 x 204-pin SO-DIMM
Graphics	Chipset	Intel® HD Graphics 500
	Graphic Engine	4K Codec Decode& Encode for H.264, MPEG2, MVC, VC-1, WMV9, H.265 / HEVC, VP8, JPEG / MJPEG
	VGA	Up to 2048 x 1280 @ 60Hz
Ethernet	LAN1	10/100/1000 Mbps Intel i210 GbE, support Wake On Lan
	LAN2	10/100/1000 Mbps Intel i210 GbE, support Wake On Lan
Audio	Interface	Realtek ALC888S, High Definition Audio. Line-out,,Line-in
IO Interface	Serial Ports	2 x RS-232/422/485 port with auto flow control
	USB Interface	4 x USB 3.0
Other	Watchdog timer	255 levels timer interval, setup by software
	TPM	Infineon SLB9665XQ 2.0
Expansion	Mini PCIe	1 x full-size mPCIe for WLAN/WWAN with SIM holder
	M.2	1 x M.2 E-key for WIFI (by CTOS or T-PN)
	iDoor	1, optional (2nd layer)
Storage	HDD/SSD	Supports 1 x SATA III Drive Bay (Compatible with 9.5mm height)
Software Support	Microsoft Windows	Win 10 IoT Enterprise LTSB
	Linux	Support by project
Power Requirement	Power Type	AT/ATX
	Power Input Voltage	12V <sub>dc</sub> (Optional 12~24V power module)
	Minimum Power Input	12 V, 5 A
	Power Adapter	AC to DC, DC12 V/5 A, 60 W with lockable DC Jack
Power Consumption	Typical	5W
	Max.	33.7W
Mechanical	Construction	Aluminum housing
	Mounting	DIN-Rail/Wall/VESA Mounting Kits (Optional)
	Dimensions (W x H x D)	133 x 46.4 x 94.2mm (5.24" x 1.83" x 3.71")
	Weight	0.7 Kg (1.55lb)
Environment	Operating Temperature	With extended temperature peripherals: -20 ~ 60 °C (-4 ~ 140 °F) with 0.7m/s air flow With 2.5-inch hard disk 0 ~ 40 °C (32 ~ 104 °F) with 0.7m/s air flow
	Storage Temperature	-40 ~ 85 °C (-40 ~ 185 °F)
	Relative Humidity	95% @ 40 °C (non-condensing)
	Vibration During Operation	With SSD: 3 Grms, IEC 60068-2-64, random, 5 ~ 500 Hz, 1 hr/axis With HDD: 0.5Grms, IEC 60068-2-64, random, 5 ~ 500 Hz, 1 hr/axis
	Shock During Operation	With SSD: 30 G, IEC 60068-2-27, half sine, 11 ms duration With HDD: 10G, IEC 60068-2-27, half sine, 11 ms duration
	EMC	CE/FCC Class B, CCC, BSMI
	Safety Certifications	UL, CB, CCC, BSMI

## Dimensions

Unit: mm

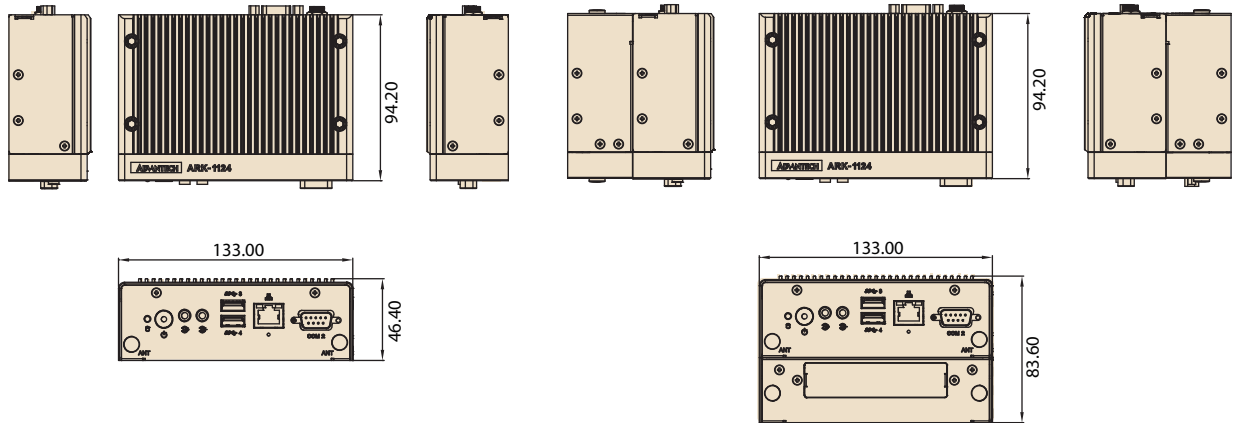

### Front Panel External I/O Mechanical Layout/Drawing

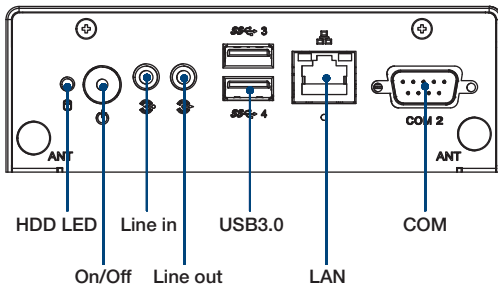

### Rear Panel External I/O Mechanical Layout/Drawing

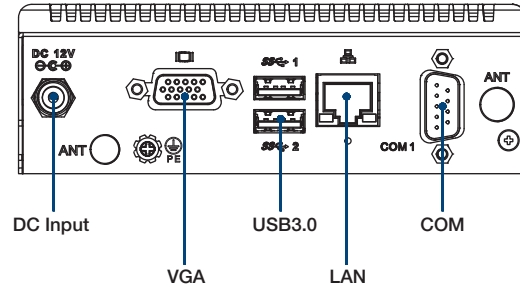

## Ordering Information

Part No.	CPU	RAM	VGA	GbE	USB 3.0	RS-232/422/485	Audio	Full-size MiniPCIe	SIM	M.2	2.5" SATA III HDD Bay	Power Input	Operating Temp.
ARK-1124U-S1A1E	Intel Celeron N3350 1.1 GHz Soc	Up to 8GB	1	2	4	2	Lin-out, Line-in	1	1	1	1	12 V <sub>DC</sub>	-20 ~ 60 °C

Note: Memory, storage and operating system bundled by request.

## Packing List

Part Number	Description
-	1 x ARK-1124U Unit
-	1 x User Manual (Simplified Chinese)
96PSA-A60W12W6	1 x A/D 100-240V 60W 12V C14 LOCKABLE DC PLUG
-	LAN clip
-	Wrench for top cover

## Optional Item for Default SKU

Part Number	Description
1702002600	Power cable 3-pin 183cm, USA type
1702002605	Power cable 3-pin 183cm, EU type
1702031801	Power cable 3-pin 183cm, UK type
AMK-W001E	ARK-112X series Wall mounting kit
AMK-V003E	ARK-112X series VESA mounting kit
AMK-R001E	ARK-112X series DIN-rail mounting kit

## Optional Embedded OS

Part Number	Description
2070015302	Win10 IoT Ent LTSB 2016 64bit, ENG

# ARK-1124H

## Intel Atom™ E3940 QC SoC With Dual HDMI/ Dual LAN/ Four USB Modular Fanless Box PC

Preliminary



### Features

- Intel Atom E3940 Quad Core SoC
- Dual HDMI independent display support 4K2K resolution
- 1 x Full-size miniPCIe with SIM holder for communication module
- 1 x M.2 E Key for WIFI module
- 1 x 2.5" SATA III SSD/HDD and 1 x mSATA
- TPM built in for well security
- 20 ~ 60 °C extended operating temperature
- 12V lockable DC jack power input
- Optional 12~24V power module (Dual Layer)
- Advantech iDoor module compatible (Dual Layer)
- Advantech WISE-PaaS/RMM support



### Specifications

		ARK-1124H-S6A1E
Processor System	CPU	Intel Atom™ E3940 Quad Core Soc
	Frequency	1.6 GHz, turbo burst 1.8 GHz
	L2 Cache	2 MB
	BIOS	AMI EFI 64 bit
Memory	Technology	DDR3L 1866 MHz
	Max. Capacity	8 GB
	Socket	1 x 204-pin SO-DIMM
Graphics	Chipset	Intel® HD Graphics 500
	Graphic Engine	4K Codec Decode& Encode for H.264, MPEG2, MVC, VC-1, WMV9, H.265 / HEVC, VP8, JPEG / MJPEG
	HDMI	HDMI 1.4b 3840 x 2160 @ 30Hz
	Dual Display	Yes, HDMI + HDMI, dual display support 4K2K resolution
Ethernet	LAN1	10/100/1000 Mbps Intel i210 GbE, support Wake On Lan
	LAN2	10/100/1000 Mbps Intel i210 GbE, support Wake On Lan
Audio	Interface	Realtek ALC888S, High Definition Audio. Line-out, Line-in
IO Interface	Serial Ports	1 x RS-232/422/485 port with auto flow control
	USB Interface	4 x USB 3.0
Other	Watchdog timer	255 levels timer interval, setup by software
Expansion	Mini PCIe	1 x full-size mPCIe for WLAN/WWAN
	M.2	1 x M.2 E-key for WIFI
	iDoor	1, optional (2nd layer)
Storage	SSD/HDD	Supports 1 x 2.5" SATA III Drive Bay (Compatible with 9.5mm height)
	mSATA	1 x Half-size mSATA (by CTOS or T-PN)
Software Support	Microsoft Windows	Windows 10 Enterprise, Windows 10 IoT Core
	Linux	Support by project
Power Requirement	Power Type	AT/ATX
	Power Input Voltage	12V <sub>DC</sub> (Optional 12~24V power module)
	Minimum Power Input	12 V, 5 A
	Power Adapter	AC to DC, DC12 V/5 A, 60 W with lockable DC Jack
Power Consumption	Typical	TBC
	Max.	TBC
Mechanical	Construction	Aluminum housing
	Mounting	DIN-Rail/Wall/VESA Mounting Kits (Optional)
	Dimensions (W x H x D)	133 x 46.4 x 94.2mm (5.24" x 1.83" x 3.71")
	Weight	0.7 Kg (1.55lb)
Environment	Operating Temperature	With extended temperature peripherals: -20 ~ 60 °C (-4 ~ 140 °F) with 0.7m/s air flow With 2.5-inch hard disk 0 ~ 40 °C (32 ~ 104 °F) with 0.7m/s air flow
	Storage Temperature	-40 ~ 85 °C (-40 ~ 185 °F)
	Relative Humidity	95% @ 40 °C (non-condensing)
	Vibration During Operation	With SSD: 3 Grms, IEC 60068-2-64, random, 5 ~ 500 Hz, 1 hr/axis. With HDD: 0.5Grms, IEC 60068-2-64, random, 5~500Hz, 3 axes, 1hr/axis
	Shock During Operation	With SSD: 30 G, IEC 60068-2-27, half sine, 11 ms duration With HDD: 10G, IEC 60068-2-27, half sine, 11 ms duration
	EMC	CE/FCC Class B, CCC, BSMI
	Safety Certifications	UL CB, CCC and BSMI

## Dimensions

Unit: mm

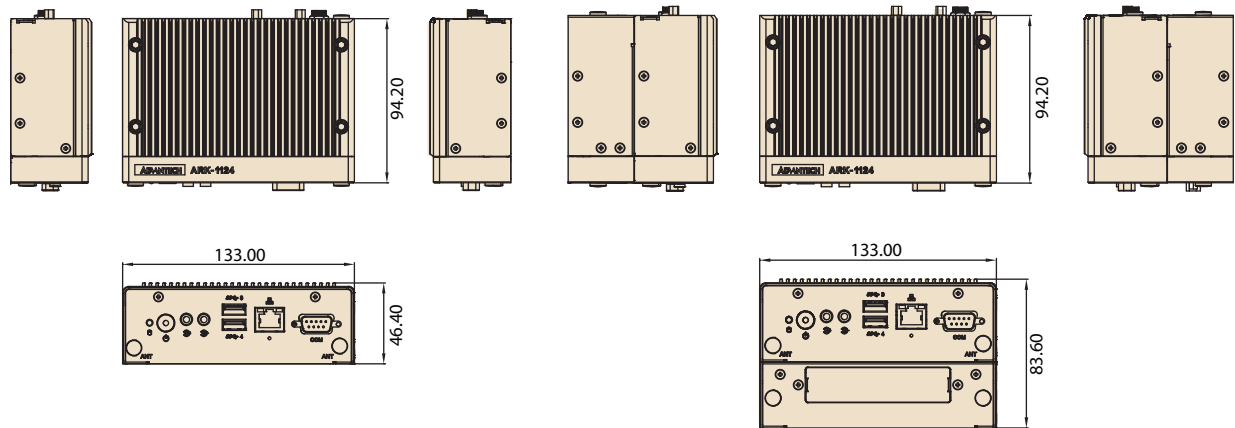

### Front Panel External I/O Mechanical Layout/Drawing

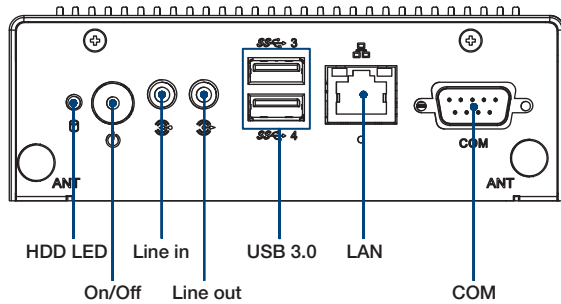

### Rear Panel External I/O Mechanical Layout/Drawing

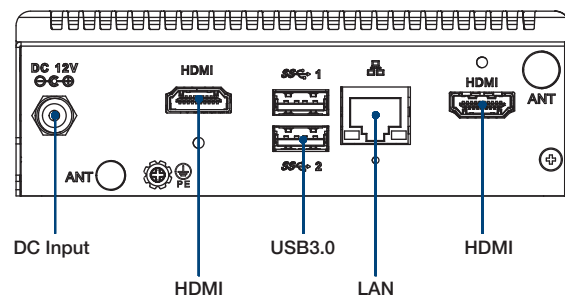

## Ordering Information

Part No.	CPU	HDMI	GbE	USB 3.0	RS-232/ 422/485	Audio	Full-size MiniPCIe	mSATA	2.5" SATA III HDD Bay	Power Input	Operating Temp.
ARK-1124H-S6A1E	Intel Atom E3940 1.6 GHz SoC	2	2	4	1	Lin-out, Line-in	1	1 (H/S)	1	12 V <sub>DC</sub>	-20 ~ 60 °C

Note: Memory, storage and operating system bundled by request.

## Packing List

Part Number	Description
-	1 x ARK-1124H Unit
-	1 x User Manual (Simplified Chinese)
96PSA-A60W12W6	A/D 100-240V 60W 12V C14 LOCKABLE DC PLUG
-	LAN clip

## Optional Embedded OS

Part Number	Description
TBC	Win10 IoT LTSB 64bit ENG

## Optional Item for Default SKU

Part Number	Description
1702002600	Power cable 3-pin 183cm, USA type
1702002605	Power cable 3-pin 183cm, EU type
1702031801	Power cable 3-pin 183cm, UK type
AMK-W001E	ARK-112X series Wall mounting kit
AMK-V003E	ARK-112X series VESA mounting kit
AMK-R001E	ARK-112X series DIN-rail mounting kit
1700023855-01	1M lockable HDMI cable
1700023856-01	3M lockable HDMI cable

# ARK Plus Extended Modules

## ARK-1124 Dual Layer Expansion Option Items

### AMO-1101 iDoor and power module kit



### Specifications

General	
Features	For iDoor and power module
Contents	Mechanical kit for expansion
Dimension	133 x 37 x 94.2 mm
Operating temperature	-20~ 60°C

### Ordering Information

#### Optional ARK Plus Mechanical Kit

P/N	Description
AMO-1101	ARK-1124 ARK Plus kit for 2nd layer expansion

\* Please select iDoor and power module.

\* AMO-1101 support both iDoor module x1 and 12-24V power module x1 (by CTOS)

#### Optional iDoor Expansion

Part Number	Description
MOS-2230-Z1201E	CANBus module, 2-Ch, USB Interface
MOS-2220-X1101E	Parallel LPT module, 1-Ch, USB Interface
MOS-2110Z-1201E	USB module, 2-Ch, PCIe Interface
MOS-2120-Z1101E	Giga LAN Ethernet module, 1-Ch, PCIe Interface
MOS-1120Y-0201E	Isolated RS-232, 2-Ch, DB9, PCIe Interface
MOS-1121Y-0201E	Isolated RS-422/485, 2-Ch, DB9, PCIe Interface
MOS-1120Y-1401E	Non-Isolated RS-232, DB37, 4-Ch, PCIe Interface
MOS-1121Y-1401E	Non-Isolated RS-422/485, DB37, 4-Ch, PCIe Interface
MOS-1130Y-0201E	Isolated CANBus, 2-Ch, DB9, PCIe Interface
MOS-1110Y-0101E	Isolated 16 DI/8 DO, 1-Ch, DB37, PCIe Interface
MOS-2220-Z1101E	High Speed COM module, 1-Ch, USB Interface

#### Optional 12-24V DC Power module

Part Number	Description
AMO-P011	12-24V DC input power module
96PSA-A60W12P2-1	AC to DC ADP, 12V/5A 60W (for AMO-P011)
1700001524	Power cord 3-pin 183cm, USA type (for AMO-P011)
170203183C	Power cord 3-pin 183cm, EU type (for AMO-P011)
170203180A	Power cord 3-pin 183cm, UK type (for AMO-P011)



Our company network supports you worldwide with offices in Germany, Austria, Switzerland, Great Britain and the USA. For more information please contact:

## Headquarters

### Germany



**FORTEC Elektronik AG**  
Lechwiesenstr. 9  
86899 Landsberg am Lech

Phone: +49 8191 91172-0  
E-Mail: [sales@forteca.de](mailto:sales@forteca.de)  
Internet: [www.forteca.de](http://www.forteca.de)

## Fortec Group Members

### Austria



**FORTEC Elektronik AG**  
**Office Vienna**

Nuschinggasse 12  
1230 Wien

Phone: +43 1 8673492-0  
E-Mail: [office@fortec.at](mailto:office@fortec.at)  
Internet: [www.fortec.at](http://www.fortec.at)

### Germany



**Distec GmbH**

Augsburger Str. 2b  
82110 Germering

Phone: +49 89 894363-0  
E-Mail: [info@distec.de](mailto:info@distec.de)  
Internet: [www.distec.de](http://www.distec.de)

### Switzerland



**ALTRAC AG**

Bahnhofstraße 3  
5436 Würenlos

Phone: +41 44 7446111  
E-Mail: [info@altrac.ch](mailto:info@altrac.ch)  
Internet: [www.altrac.ch](http://www.altrac.ch)

### United Kingdom



**Display Technology Ltd.**

5 The Oaks Business Village  
Revenge Road, Lordswood  
Chatham, Kent, ME5 8LF

Phone: +44 1634 672755  
E-Mail: [info@displaytechnology.co.uk](mailto:info@displaytechnology.co.uk)  
Internet: [www.displaytechnology.co.uk](http://www.displaytechnology.co.uk)

### USA



**Apollo Display Technologies, Corp.**

87 Raynor Avenue,  
Unit 1 Ronkonkoma,  
NY 11779

Phone: +1 631 5804360  
E-Mail: [info@apolloDisplays.com](mailto:info@apolloDisplays.com)  
Internet: [www.apolloDisplays.com](http://www.apolloDisplays.com)