



DLD1215-I V1
12.1" TFT LCD, LED Backlight 1000nits, 1024x768

The **DLD1215-I V1** is a 12.1 inch industrial grade sunlight readable LCD, with high brightness 1000 nits, it produce sharp images, crisp text and lifelike colors. The Durapixel LED backlight technology ensures high reliability and low power consumption, suitable for outdoor application, kiosk, factory automation, military, transportation and gaming application.

Key Features

- High Brightness 1000 nits
- Sunlight Readable
- Wide Operating Temp.
- Wide Viewing Angle of 178°(H), 178°(V)
- Low Power Consumption
- BL MTBF: 100,000 hours



Specifications

Model Name	DLD1215-I V1
Description	12.1" TFT LCD, LED Backlight 1000 nits, 1024x768
Screen Size	12.1"
Display Area (mm)	245.76(H) x 184.32(V)
Brightness	1000 cd/m ²
Resolution	1024x768
Aspect Ratio	4 : 3
Contrast Ratio	1200 : 1
Pixel Pitch (mm)	0.24(H) x 0.24(V)
Pixel Pre Inch (PPI)	106
Viewing Angle	178°(H),178°(V)
Color Saturation (NTSC)	82%
Display Colors	16.7M
Response Time (Typical)	25ms
Panel Interface	LVDS
AD Board Input Interface	DVI, HDMI, DP
Input Power	DC12V
Power Consumption	14.8W
OSD Key	4 Keys (Power Switch, Menu, +, -)
OSD Control	Brightness, Color, Contrast, Auto Turing, H/V Position...etc
Dimensions (mm)	267.2 x 212.12 x 48.2
Bezel Size(U/B/L/R)	13.1/13.1/9.92/9.92
Weight (Net)	1.5 kg
Mounting	75x75mm
Operating Temperature	-30 °C ~ 60 °C
Storage Temperature	-40 °C ~ 70 °C

DLD= Panel + LED Driving Board + AD Control Board + Housing

*Specifications are subject to change without notice.
 All brands or product names are trademarks or registered trademarks of their respective companies.*



Mechanical Drawing

Outline Dimensions

Unit:mm

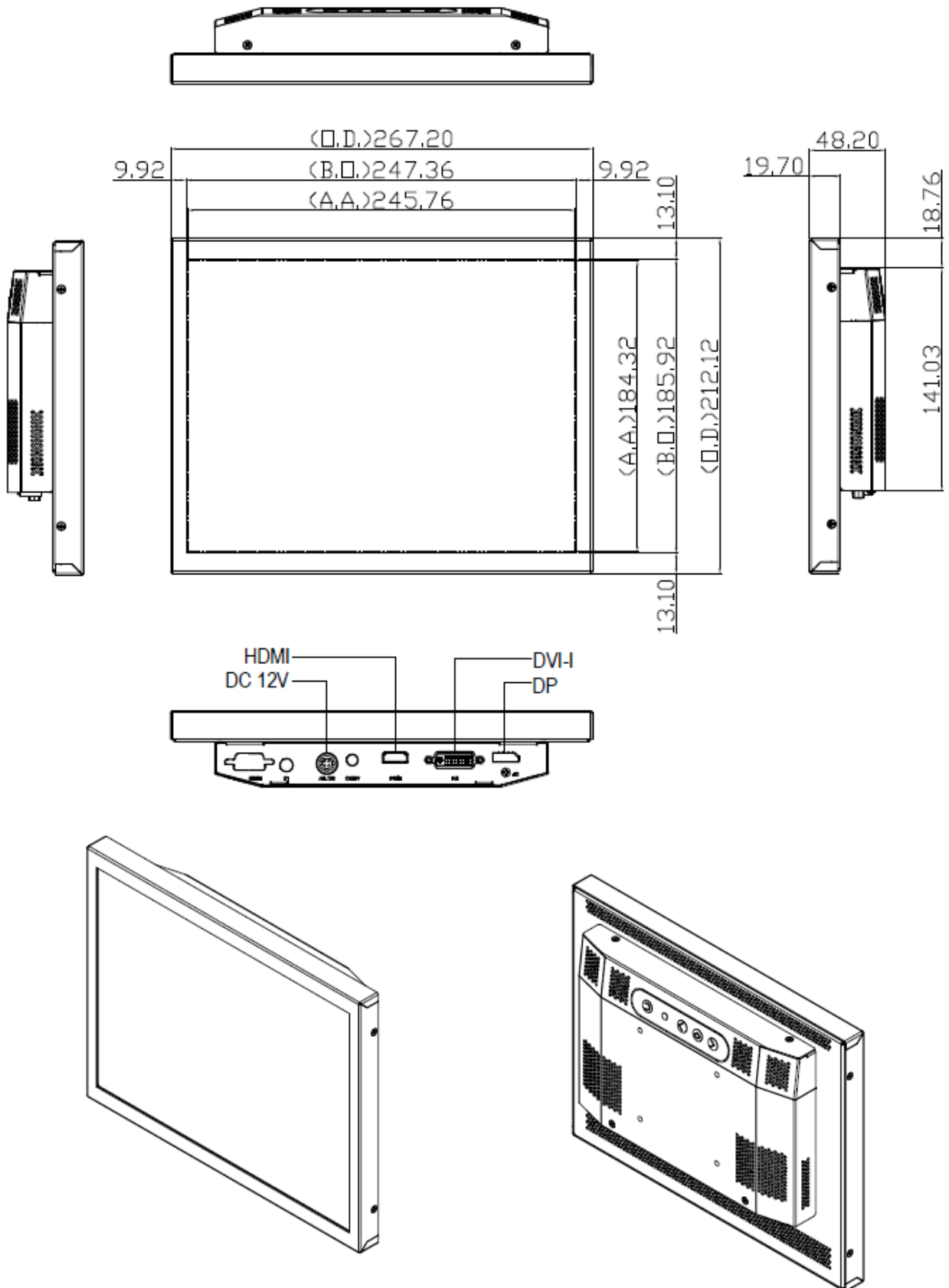

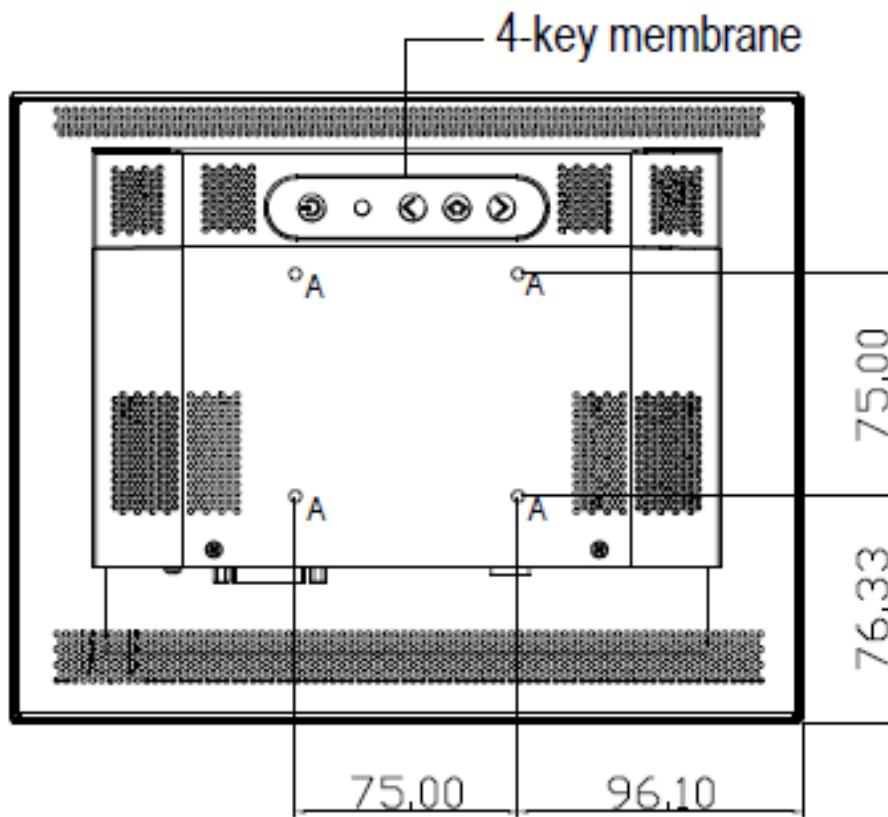

Note :

O.D. : OUTLINE DIMENSION

B.O. : BEZEL OPENING

A.A. : LCD ACTIVE AREA

A : 4-M4_USER HOLE_MAX Depth=5mm



Ordering Information

Part Number	Description
DLD1215-INB-Q01	12.1",1000nits,1024x768,LID12C,AD8891DHP, O/B,DC12V, 3in1,V1

Optional Accessories

Part Number	Description
840612051212	ADAPTER,AC/DC,12V/5A,60W,Power-Din-4P,CWT,G99-ABF060F-N022,Efficiency-level-6,R
810618301010	CABLE.POWER.AC.1830mm USA type
810618301090	CABLE,POWER,AC,1830mm Europe type
810618301050	CABLE.POWER.AC.1830mm UK type
810618301170	CABLE.POWER,AC,1830mm Australia type
810618301031	CABLE.POWER.AC.1830mm Japan type

Customer request

Touch	SCT (Single-Touch), PCT (Multi-Touch)
Glass	Tempered glass, AR coating.....