



OUR GLOBAL
COMPETENCE
CENTRES

 APOLLO DISPLAY
TECHNOLOGIES



 DISTEC



 DISPLAY
TECHNOLOGY



Datasheet

SGD

GKVGC1MNHB1E0

SG-01-024

Product Specification				
	Model: GKVGC1MNHB1E0	Rev. No.	Issued Date.	Page.
		A	2018/Jun/25	1 / 26

Thin-Film-Transistor LCD Module
 Model: GKVGC1MNHB1E0

Acceptance

Solomon Goldentek Display Corp.
NO. 18 Ta-Yeh St., Ta-Fa Industrial Park, Ta-Liao
Hsiang, Kaohsiung Hsien 831, TAIWAN , R.O.C.
 FAX: 886-7-7886800

Approved and Checked by

Approved by	Checked by		Made by
			

Product Specification



Model: GKVGC1MNHB1E0

Rev. No.

Issued Date.

Page.

A

2018/Jun/25

2 / 26

Revise Records

Rev.	Date	Contents	Written	Approved
A	2018/06/25	Preliminary Specification	Carl Lin	Ken Hung

Special Notes

Note1.	
Note2.	

Product Specification				
	Model: GKVGC1MNHB1E0	Rev. No.	Issued Date.	Page.
		A	2018/Jun/25	3 / 26

Contents

- 1. General Description and Features..... 4**
- 1.1 Features 4
- 1.2 LCD Module 4
- 2. Mechanical Information 4**
- 3. Electrical Specifications..... 5**
- 3.1 Absolute Max. Ratings 5
- 3.2 AC Timing Characteristic of The LCD 6
- 3.3 Back-Light Unit 8
- 4. Optical Characteristics..... 9**
- 4.1 Optical characteristic of the LCD 9
- 5. I/O Terminal 12**
- 5.1 Pin Assignment (CN1 P/N: Starconn 093G30-B0001A-G4 or equivalent.) 12
- 5.2 Back Light Unit (CN2 P/N: 35001HS-02L or equivalent.) 13
- 5.3 Block Diagram 14
- 6. Displayed Color and Input Data..... 15**
- 7. Reliability Condition 16**
- 8. Dimensional Outlines..... 17**

Product Specification

	Model: GKVGC1MNHB1E0	Rev. No.	Issued Date.	Page.
		A	2018/Jun/25	4 / 26

1. General Description and Features

GKVGC1MNHB1E0 is a transmissive type color active matrix TFT (Thin Film Transistor) liquid crystal display (LCD) that uses amorphous silicon TFT as a switching device. This model is composed of a TFT-LCD module, a driver circuit and a back-light unit. Graphics and texts can be displayed on a WXGA 1280 (W) x RGB x 800 (H) dots (16:10 aspect ratio) with 262,144 colors by supplying 18 bits data signal (6bits/each color). The following table described the features of GKVGC1MNHB1E0.

1.1 Features

- Transmissive and back-light with 24 LEDs are available.
- LVDS 6/8 bits.
- Data enable mode.
- RoHS Compliance
- MVA

1.2 LCD Module

Item	Specification	Unit
Screen Size	12.1 inches	Diagonal
Display Resolution	1280 (H) x 800 (V)	Pixel
Active Area	261.12(H) x 163.2(V)	mm
Outline Dimension	278(H) x 184(V) x 7.3(T)	mm
Display Mode	Normally Black/Transmissive	--
Pixel Arrangement	R,G,B Vertical Stripe	--
Pixel Size	0.204(H) x 0.204(V)	mm
Surface Treatment	Glass 7H(min.)	
Display Color	262K/16.2M	--
Input Interface	LVDS 6/8 bit Interface	--

2. Mechanical Information

Item	Min.	Typ.	Max.	Unit	Note	
Module Size	Horizontal (H)	(277.7)	(278)	(278.3)	mm	
	Vertical (V)	(183.7)	(184)	(184.3)	mm	
	Thickness (T)	(7.0)	(7.3)	(7.6)	mm	(1)
Weight	-	(TBD)		g	--	

Note (1) Not Include Component. Refer to the Outline Dimension Drawing as attached.

Product Specification

	Model: GKVGC1MNHB1E0	Rev. No.	Issued Date.	Page.
		A	2018/Jun/25	5 / 26

3. Electrical Specifications

3.1 Absolute Max. Ratings

3.1.1 Absolute Ratings of Environment

If the operating condition exceeds the following absolute maximum ratings, the TFT LCD module may be damaged permanently.

(Ta=25±2°C, V_{SS}=GND=0)

Item	Symbol	Min.	Max.	Unit	Note
Storage temperature	T _{STG}	-30	80	°C	(1)
Operating temperature	T _{OPR}	-20	70	°C	(1,2,3)

Note (1) 90 % RH Max. (40 °C ≥ Ta). Maximum wet-bulb temperature at 39 °C or less. (Ta > 40 °C) No condensation.

Note (2) In case of below 0°, the response time of liquid crystal (LC) becomes slower and the color of panel becomes darker than normal one. Level of retardation depends on temperature, because of LC's character

Note (3) Only operation is guaranteed at operating temperature. Contrast, response time, another display quality are evaluated at +25°C.

3.1.2 Electrical Absolute Maximum Ratings

3.1.2.1 TFT-LCD Module

(V_{SS}=GND=0)

Parameter	Symbol	Min.	Max.	Unit	Remark
Power supply voltage	V _{CC}	-0.3	4.0	V	
Logic Input Voltage	V _{IN}	-0.3	V _{CC} +0.3	V	

3.1.2.2 Backlight Unit

(V_{SS}=GND=0)

Parameter	Symbol	Min.	Max.	Unit	Remark
Current of Backlight Unit	IB	--	(600)	mA	
Voltage of Backlight Unit	VB	--	(25.62)	V	

Product Specification

	Model: GKVGC1MNH1E0	Rev. No.	Issued Date.	Page.
		A	2018/Jun/25	6 / 26

3.1.3 DC Electrical Characteristics of the TFT LCD

(Ta=25±2°C, V_{SS}=GND=0)

Item	Symbol	Min.	Typ.	Max.	Unit	Remark
Power supply	VCC	3.0	3.3	3.6	V	
LVDS Differential Input High Threshold	V _{TH(LVDS)}	-	-	+100	mv	
LVDS Differential Input Low Threshold	V _{TL(LVDS)}	-100	-	-	mv	
Power Supply current	ICC	(350)	(385)	(420)	mA	Note 1

Note1: f_v =60Hz , Ta=25°C , Display pattern : Black pattern



3.2 AC Timing Characteristic of The LCD

3.2.1 Timing Condition (DE only mode)

Signal	Parameter	Symbol	Min.	Typ.	Max.	Unit.	Remark
DCLK	CLK frequency	1/T _C	67.45	71	74.55	MHz	
DE	Vertical Total Time	TV	810	823	1000	TH	
	Vertical Addressing Time	TVD	800	800	800	TH	
	Horizontal Total Time	TH	1360	1440	1600	T _C	
	Horizontal Addressing Time	THD	1280	1280	1280	T _C	

Product Specification



Model: GKVGC1MNH1E0

Rev. No.

Issued Date.

Page.

A

2018/Jun/25

7 / 26

3.2.2 Timing Characteristic

3.2.2.1 DE and Data Input Timing

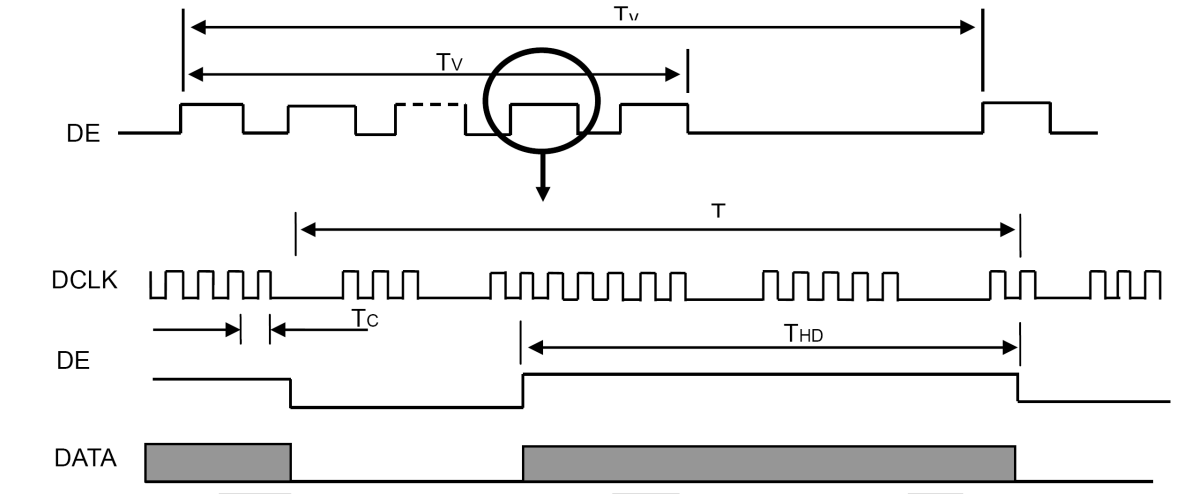

Product Specification

	Model: GKVGC1MNH1E0	Rev. No.	Issued Date.	Page.
		A	2018/Jun/25	8 / 26

3.3 Back-Light Unit

The Back-light system is an edge-lighting type with 24 white LED (Light Emitting Diode)s. The characteristics of 24 white LEDs are shown in the following tables.

(Ta= Room Temp)

Characteristics	Symbol	Min.	Typ.	Max.	Unit	Note
Forward Voltage	VB	(21.82)	-	(25.62)	V	
Forward Current	IB	-	(600)	-	mA	(1)
Power Consumption	P _{BL}	-	(TBD)	-	mW	
LED Life Time	-	(30,000)			Hrs	

Note (1) LEDs in 4 series x 6 parallel .

(2) The environmental conducted under ambient air flow ,at Ta=25±2°C, 60%RH±5%

Product Specification

	Model: GKVGC1MNH1E0	Rev. No.	Issued Date.	Page.
		A	2018/Jun/25	9 / 26

4. Optical Characteristics

4.1 Optical characteristic of the LCD

The following items are measured under stable conditions. The optical characteristics should be measured in a dark room or equivalent state with the methods.

Measuring equipment: BM-7A

Item	Symbol	Condition	Min	Typ	Max	Unit	Note	
Brightness	B		(1000)	(1300)	-	cd/m ²		
Response time	T _r	θ=0°	-	15	20	ms	.	
	T _f		-	10	15	ms		
Contrast ratio	CR	At optimized viewing angle	800	1000	-	--		
Luminance Uniformity	ΔL		70	-	-	%		
Color Chromaticity (CIE 1931)	White	θ=0° Normal Viewing Angle	W _x	(0.27)	(0.32)	(0.37)	--	BM-7A
			W _y	(0.32)	(0.37)	(0.42)		
Viewing Angle	Hor.	CR≥10	θ _R	80	88	-	Degree	
			θ _L	80	88	-		
	Ver.		θ _U	80	88	-		
			θ _D	80	88	-		

Product Specification

	Model: GKVGC1MNHB1E0	Rev. No.	Issued Date.	Page.
		A	2018/Jun/25	10 / 26

a. Test equipment setup

After stabilizing and leaving the panel alone shall be warmed up for the stable operation of LCM, the measurement should be executed. Measurement should be executed in a stable, windless, and dark room. Optical specifications are measured by Topcon BM-7(fast) with a viewing angle of 2° at a distance of 50cm and normal direction.

b. Definition of response time: Tr and Tf

The response time is defined as the following figure and shall be measured by switching the input signal for "black" and "white".

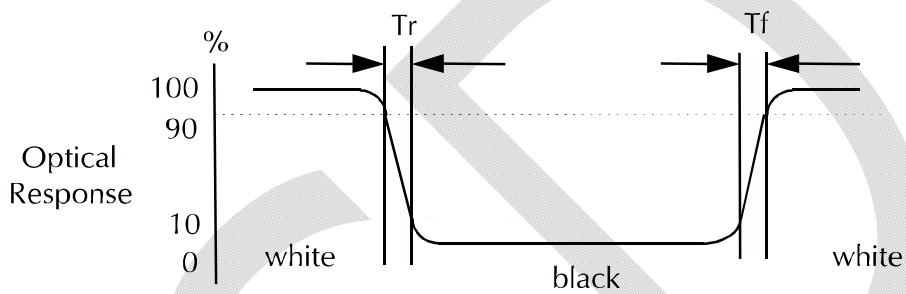

c. Definition of contrast ratio:

$$\text{Contrast Ratio (CR)} = \frac{\text{Brightness measured when LCD is at "white state"}}{\text{Brightness measured when LCD is at "black state"}}$$

d. Measured at the center area of the panel when all the input terminals of LCD panel are electrically opened.

Product Specification

	Model: GKVGC1MNH1E0	Rev. No.	Issued Date.	Page.
		A	2018/Jun/25	11 / 26

e. View Angle

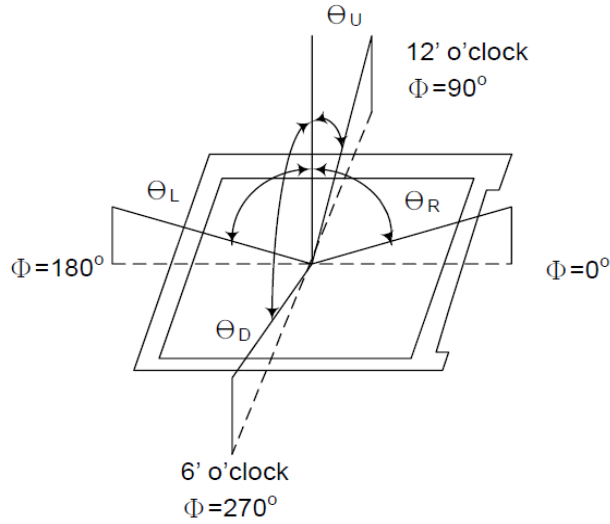

f. Definition of Luminance of White: Luminance of white at the center points

Light Source of Back-Light Unit	LED Type
---------------------------------	----------

g. Definition of White Uniformity

$$\text{White Uniformity} = \frac{\text{Min. luminance of white among 9-points}}{\text{Max. luminance of white among 9-points}} \times 100\%$$

h. The definition of Color Gamut –Color Chromaticity CIE 1931

Color coordinate of white & red, green, blue at center point.

$$\text{Color Gamut : NTSC(\%)} = \left(\frac{\text{RGB Triangle Area}}{\text{NTSC Triangle Area}} \right) \times 100$$

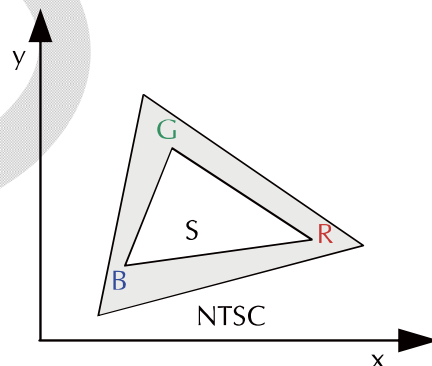

Product Specification

	Model: GKVGC1MNH1E0	Rev. No.	Issued Date.	Page.
		A	2018/Jun/25	12 / 26

5. I/O Terminal

5.1 Pin Assignment (CN1 P/N: Starconn 093G30-B0001A-G4 or equivalent.)

Pin No.	Symbol	I/O	Function	Remark
1	NC	-	NO Connect	
2	NC	-	NO Connect	
3	NC	-	NO Connect	
4	NC	-	NO Connect	
5	NC	-	NO Connect	
6	NC	-	NO Connect	
7	GND	P	Ground	
8	GND	P	Ground	
9	VCC	P	Power Supply +3.3V	
10	VCC	P	Power Supply +3.3V	
11	GND	P	Ground	
12	GND	P	Ground	
13	RX0-	I	Negative LVDS differential data 0 input	
14	RX0+	I	Positive LVDS differential data 0 input	
15	GND	P	Ground	
16	RX1-	I	Negative LVDS differential data 1 input	
17	RX1+	I	Positive LVDS differential data 1 input	
18	GND	P	Ground	
19	RX2-	I	Negative LVDS differential data 2 input	
20	RX2+	I	Positive LVDS differential data 2 input	
21	GND	P	Ground	
22	RXCLK-	I	Negative LVDS differential clock input	
23	RXCLK+	I	Positive LVDS differential clock input	
24	GND	P	Ground	
25	RX3-	I	Negative LVDS differential data 3 input	
26	RX3+	I	Positive LVDS differential data 3 input	
27	GND	P	Ground	
28	SEL6/8	I	LVDS 6/8 bit select function control, Low or NC : 6bit input mode High : 8bit input mode	
29	GND	P	Ground	
30	GND	P	Ground	

Product Specification

	Model: GKVGC1MNHB1E0	Rev. No.	Issued Date.	Page.
		A	2018/Jun/25	13 / 26

I: Input, P: Power

Notes:

- 1) NC Pin must be retained; this pin can't contact VSS or other signal.
- 2) VSS Pin must ground contact, can not be floating.

5.2 Back Light Unit (CN2 P/N: 35001HS-02L or equivalent.)

Pin No.	Symbol	Function	Remark
1	LEDA	Power Supply for LED backlight	RED
2	LEDK	GND for LED backlight	BLACK

Product Specification



Model: GKVGC1MNH1E0

Rev. No.

Issued Date.

Page.

A

2018/Jun/25

14 / 26

5.3 Block Diagram

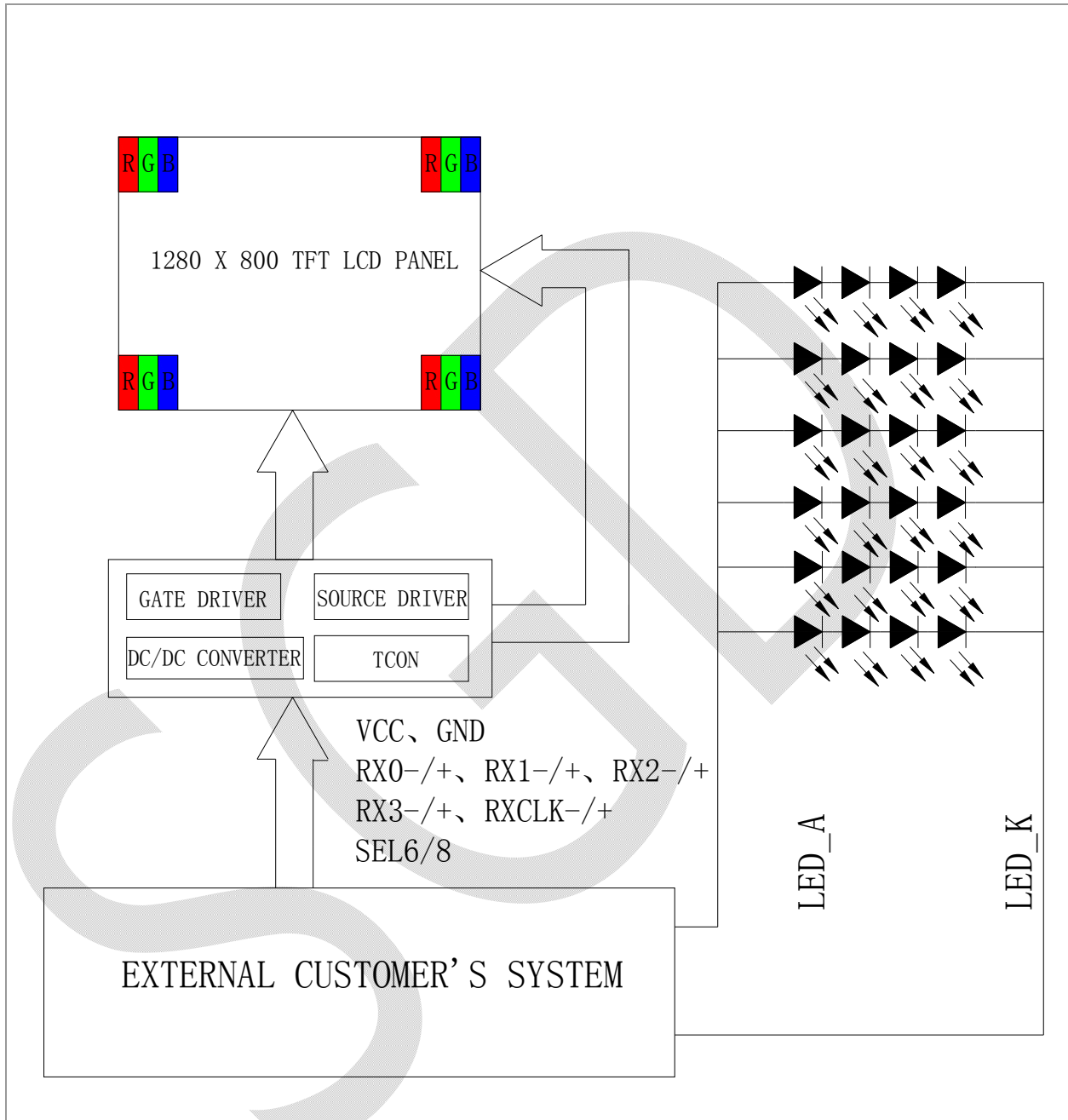

Product Specification

	Model: GKVGC1MNH1E0	Rev. No.	Issued Date.	Page.
		A	2018/Jun/25	15 / 26

6. Displayed Color and Input Data

	Color & Gray Scale	Data Signal																	
		R5	R4	R3	R2	R1	R0	G5	G4	G3	G2	G1	G0	B5	B4	B3	B2	B1	B0
Basic Color	Black	0	0	0	0	0	0	0	0	0	0	0	0	0	0	0	0	0	0
	Red(0)	1	1	1	1	1	1	0	0	0	0	0	0	0	0	0	0	0	0
	Green(0)	0	0	0	0	0	0	1	1	1	1	1	1	0	0	0	0	0	0
	Blue(0)	0	0	0	0	0	0	0	0	0	0	0	0	1	1	1	1	1	1
	Cyan	0	0	0	0	0	0	1	1	1	1	1	1	1	1	1	1	1	1
	Magenta	1	1	1	1	1	1	0	0	0	0	0	0	1	1	1	1	1	1
	Yellow	1	1	1	1	1	1	1	1	1	1	1	1	0	0	0	0	0	0
	White	1	1	1	1	1	1	1	1	1	1	1	1	1	1	1	1	1	1
Red	Black	0	0	0	0	0	0	0	0	0	0	0	0	0	0	0	0	0	0
	Red(62)	0	0	0	0	0	1	0	0	0	0	0	0	0	0	0	0	0	0
	Red(61)	0	0	0	0	1	0	0	0	0	0	0	0	0	0	0	0	0	0
	:	:	:	:	:	:	:	:	:	:	:	:	:	:	:	:	:	:	:
	Red(31)	0	1	1	1	1	1	0	0	0	0	0	0	0	0	0	0	0	0
	:	:	:	:	:	:	:	:	:	:	:	:	:	:	:	:	:	:	:
	Red(1)	1	1	1	1	1	0	0	0	0	0	0	0	0	0	0	0	0	0
	Red(0)	1	1	1	1	1	1	0	0	0	0	0	0	0	0	0	0	0	0
Green	Black	0	0	0	0	0	0	0	0	0	0	0	0	0	0	0	0	0	0
	Green(62)	0	0	0	0	0	0	0	0	0	0	0	1	0	0	0	0	0	0
	Green(61)	0	0	0	0	0	0	0	0	0	0	1	0	0	0	0	0	0	0
	:	:	:	:	:	:	:	:	:	:	:	:	:	:	:	:	:	:	:
	Green(31)	0	0	0	0	0	0	0	1	1	1	1	0	0	0	0	0	0	0
	:	:	:	:	:	:	:	:	:	:	:	:	:	:	:	:	:	:	:
	Green(1)	0	0	0	0	0	0	1	1	1	1	1	0	0	0	0	0	0	0
	Green(0)	0	0	0	0	0	0	1	1	1	1	1	1	0	0	0	0	0	0
Blue	Black	0	0	0	0	0	0	0	0	0	0	0	0	0	0	0	0	0	0
	Blue(62)	0	0	0	0	0	0	0	0	0	0	0	0	0	0	0	0	0	1
	Blue(61)	0	0	0	0	0	0	0	0	0	0	0	0	0	0	0	0	1	0
	:	:	:	:	:	:	:	:	:	:	:	:	:	:	:	:	:	:	:
	Blue(31)	0	0	0	0	0	0	0	0	0	0	0	0	0	1	1	1	1	1
	:	:	:	:	:	:	:	:	:	:	:	:	:	:	:	:	:	:	:
	Blue(1)	0	0	0	0	0	0	0	0	0	0	0	0	1	1	1	1	1	0
	Blue(0)	0	0	0	0	0	0	0	0	0	0	0	0	1	1	1	1	1	1

0 : Low level voltage, 1 :High level voltage

Each basic color can be displayed in 64 gray scales from 6 bit data signals. With the combination of total 18 bit data signals, the 262,144-color display can be achieved on the screen.

Product Specification

	Model: GKVGC1MNH1E0	Rev. No.	Issued Date.	Page.
		A	2018/Jun/25	16 / 26

7. Reliability Condition

No change on display and in operation under the following test condition.

Condition: Unless otherwise specified, tests will be conducted under the following condition.

Temperature: 20±5°C.

Humidity: 65±5%RH.

Tests will be not conducted under functioning state.

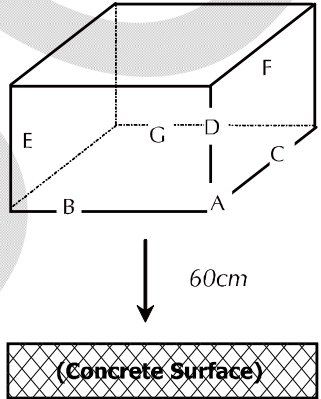
No.	Parameter	Condition	Notes
1	High Temperature Operating	70°C±2°C, 240hrs (Operation state).	
2	Low Temperature Operating	-20°C±2°C, 240hrs (Operation state).	1
3	High Temperature Storage	80°C±2°C, 240hrs.	2
4	Low Temperature Storage	-30°C±2°C, 240hrs.	1,2
5	High Temperature and High Humidity Operation Test	60°C±2°C, 90%, 240hrs.	1,2
6	Vibration Test	Total fixed amplitude: 3.5mm. Vibration Frequency: 9~500Hz. One cycle 60 seconds to 3 direction of X, Y, Z each 15 minutes.	3
7	Vibration Test (Non-Operating)	5-9Hz: 3.5mm amplitude, 9-500Hz: 1g-each 10cycles/axis (X,Y,Z): 1 octave/min	
8	Shock (Non-Operating)	25G, 6ms, half sine wave, 1 time for +/-X,+/-Y,+/-Z	
9	Drop Test	To be measured after dropping from 60cm high on the concrete surface in packing state. 	<p><i>Dropping method corner dropping:</i></p> <p><i>A corner: Once edge dropping.</i></p> <p><i>B, C, D edge: Once face dropping.</i></p> <p><i>E, F, G face: Once.</i></p>

- Notes:
1. No dew condensation to be observed.
 2. The function test shall be conducted after 4 hours storage at the normal temperature and humidity after removed from the test chamber.
 3. Vibration test will be conducted to the product itself without putting I in a container.

Product Specification



Model: GKVGC1MNHBE0

Rev. No.

Issued Date.

Page.

A

2018/Jun/25

17 / 26

8. Dimensional Outlines

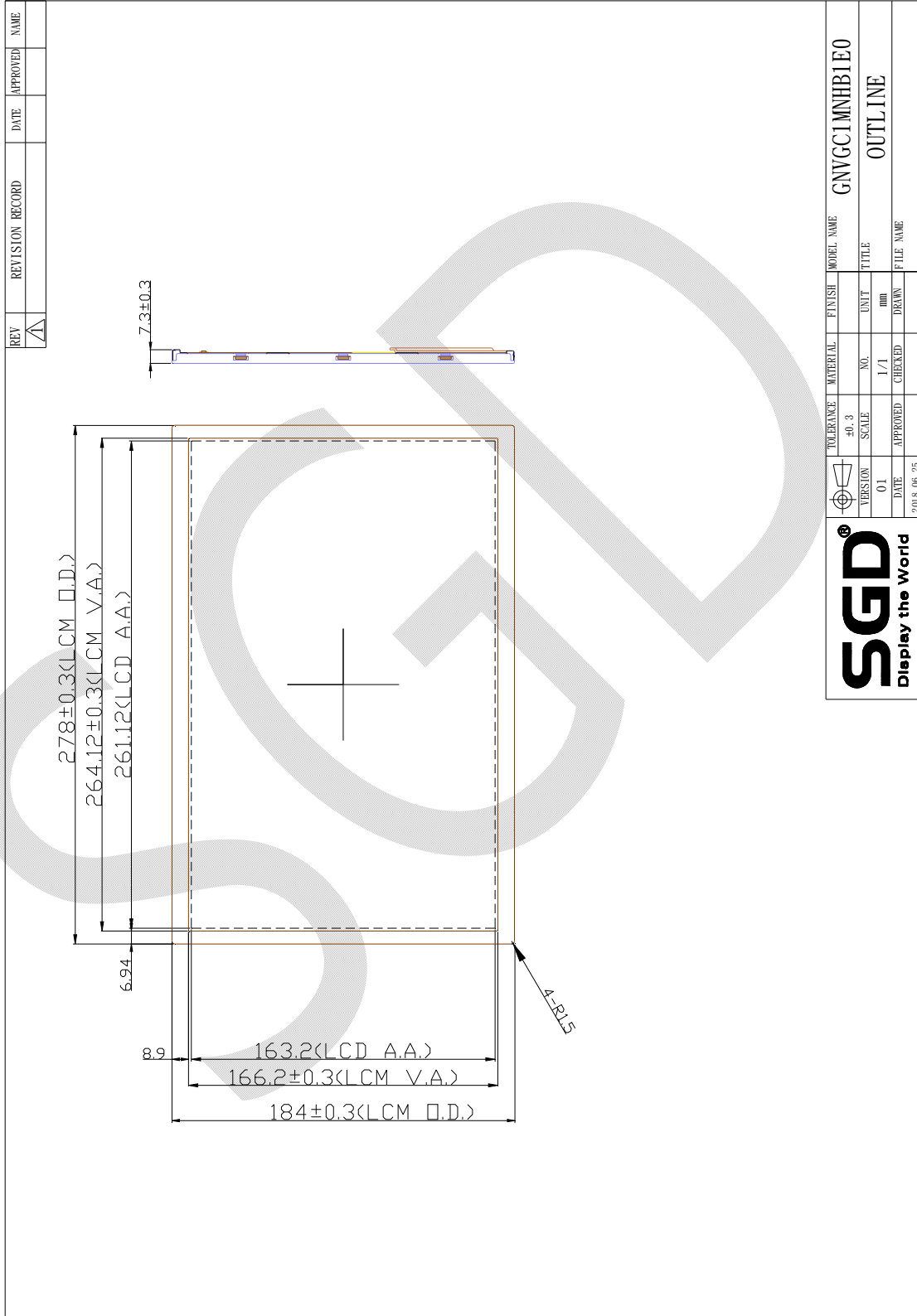

Product Specification



Model: GKVGC1MNH1E0

Rev. No.

Issued Date.

Page.

A

2018/Jun/25

18 / 26

REV	REVISION RECORD	DATE	APPROVED NAME
△			

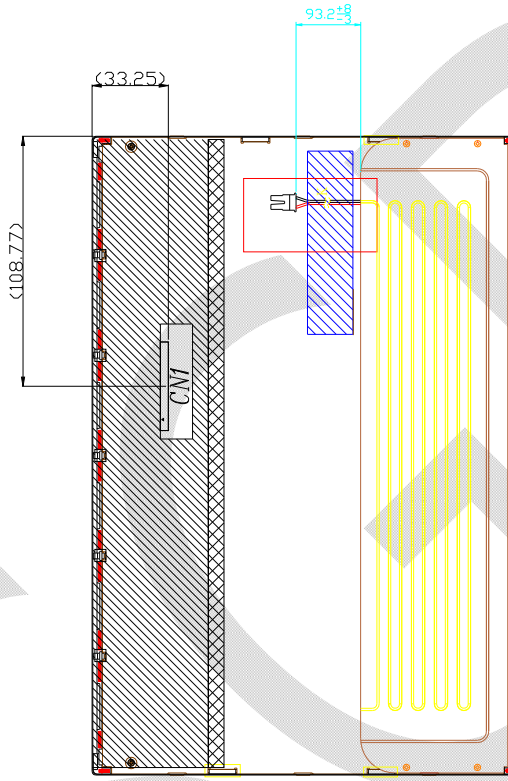

- Note:
1. CN1: Starconn 093G30-B0001A-G4 or Equivalent
 2. CN2: 35001HS-02L or Equivalent

TOLERANCE	MATERIAL	FINISH	MODEL NAME
±0.3			GKVGC1MNH1E0
VERSION	SCALE	NO.	UNIT
01		1/1	mm
DATE	APPROVED	CHECKED	DRAWN
2018.06.25			
FILE NAME	OUTLINE		



Product Specification

	Model: GKVGC1MNHB1E0	Rev. No.	Issued Date.	Page.
		A	2018/Jun/25	19 / 26

10. Description

This document shall be applied to TFT-LCD Module for 12.1" TFT

10.1 The environmental condition of inspection

The environmental condition and visual inspection shall be conducted as below.

- (1) Ambient temperature : 15~25°C
- (2) Humidity : 25~75 %RH
- (3) External appearance inspection shall be conducted by using a single 20W fluorescent lamp or equivalent illumination.
- (4) Panel visual inspection on the operation condition for cosmetic shall be conducted at the distance 35cm or more between the LCD open cell and eyes of inspector.
 - a) Ambient Illumination : 300 ~ 500 Lux for external appearance inspection
 - b) Ambient Illumination : 100 ~ 200 Lux for light on inspection
- (5) The viewing angle :
 - a) 15 degree to the front surface of display panel in vertical direction.
 - b) 45 degree to the front surface of display panel in horizontal direction.
- (6) ND filter shall be conducted at the distance 2 cm to front surface of display panel and shall be conducted at the distance 35 cm between the LCD open cell and eyes of inspector.

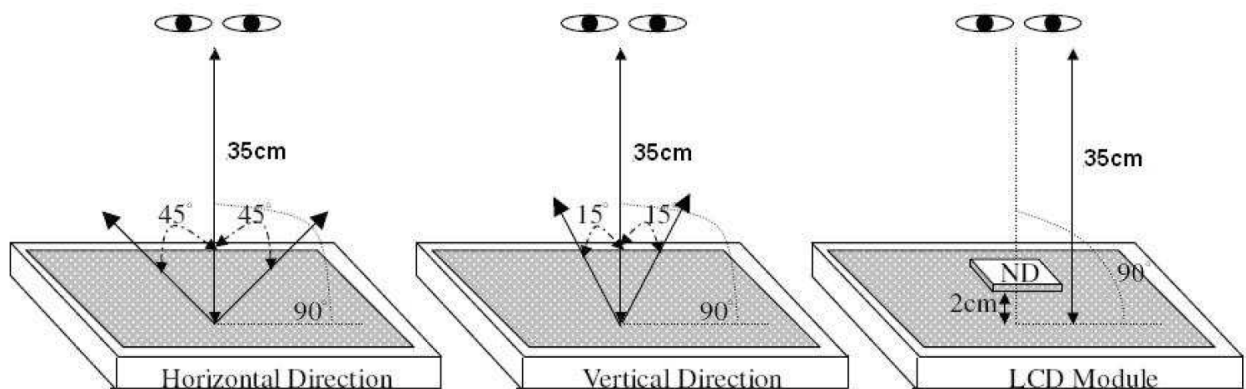

Product Specification				
	Model: GKVGC1MNHB1E0	Rev. No.	Issued Date.	Page.
		A	2018/Jun/25	20 / 26

10.2 Classification of defects

Defects are classified two types, major defect and minor defect according to the defect. And, the definition of defects is classified as below.

(1) Major defect

Any defect may result in functional failure, or reduce the usability of product for its purpose. For example, electrical failure, deformation and etc..

(2) Minor defect

A defect that is not to reduce the usability of product for its intended purpose and un-uniformity, dot defect and etc..

The criteria on major or minor judgment will be according with the classification of defects.

10.3 Classification of defects

(1) Luminance condition for white pattern : 400 ~ 600 nits for light on inspection.

(2) Definition of dot defect induced from the panel inside

- a) Bright dot : Dots appear bright and unchanged in size in which module is displaying under black pattern.
- b) Dark dot : Dots appear dark and unchanged in size in which module is displaying under pure red green, blue, white picture.
- c) 2 dot adjacent = 1pair.
- d) Picture :

(a) Full dot

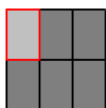

(b) 2 Full dot adjacent

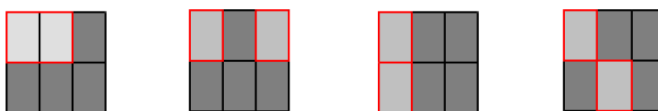

(c) Spot defect

Product Specification

	Model: GKVGC1MNHBE0	Rev. No.	Issued Date.	Page.
		A	2018/Jun/25	21 / 26

(3) Display Inspection standards

Items		Acceptable Count
Bright dot	Random	$N \leq 3$
	2 dots adjacent	$N \leq 1$
	3 dots adjacent or more	$N \leq 0$
Dark dot	Random	$N \leq 5$
	2 dots adjacent	$N \leq 1$
	3 dots adjacent or more	$N \leq 0$
Total Bright and dark dot		$N \leq 5$
Foreign Black/White/Bright Spot		$D \leq 0.15\text{mm}$, Ignore $0.15 < D \leq 0.5\text{mm}$, $N \leq 4$ It is shown in Fig.6
Foreign Black/White/Bright Lint		$W \leq 0.05\text{mm}$, Ignore $0.05 < W \leq 0.1\text{mm}$, $0.3 < L \leq 2.0\text{mm}$, $N \leq 4$ It is shown in Fig.7
Debris		$D \leq 0.35\text{mm}$, $N \leq 2$ $L \leq 0.5\text{mm}$, $N \leq 2$ It is shown in Fig.6 & Fig.7
Polarizer	Dent/Bubble	Avg. $0.15 < D \leq 0.5\text{mm}$, $N \leq 4$ It is shown in Fig.6
	Scratches	$W \leq 0.05\text{mm}$, Ignore $0.05 < W \leq 0.1\text{mm}$, $0.3 < L \leq 2.0\text{mm}$, $N \leq 4$ It is shown in Fig.7
Distance	Minimum Distance Between Bright dots	$L \geq 10\text{mm}$
	Minimum Distance Between Dark dots	$L \geq 10\text{mm}$
Display Failure(V-Line/H/Line/Cross Line etc.)		Not allowable
Mura	Not visible through 6% ND filter in 50% gray pattern or judge by limit sample if necessary	
Remark: This measurement condition is at center luminance of white 450 cd/m ²		

Product Specification

	Model: GKVGC1MNHB1E0	Rev. No.	Issued Date.	Page.
		A	2018/Jun/25	22 / 26

(4) Appearance inspection

Item	Standards	
Panel Crack	Not allowable. It is shown in Fig.1.	
Broken CF (include CF Corner)/ Non-Lead Side of TFT	Min. distance between the broken and dot area, $d_1 \geq 2.0\text{mm}$, Neglect $d_1 < 2.0\text{mm}$, $N \leq 0$ It is shown in Fig.2.	
Broken of TFT Lead Side	$W \leq 1.0\text{mm}$, It is shown in Fig.3.	
Broken Corner of TFT Lead Side	The second cross mark can't been damaged It is shown in Fig.4.	
Burr of TFT/CF Edge	The distance of burr from the edge of TFT/CF, $d_2 \leq 0.2\text{mm}$ It is shown in Fig.5.	
Polarizer	Dent /Bubble	Avg. $0.15 < D \leq 0.5 \text{ mm}$, $N \leq 4$ It is shown in Fig. 6.
	Scratches	$W \leq 0.05\text{mm}$, Ignore $0.05 < W \leq 0.1 \text{ mm}$, $0.3 < L \leq 10.0 \text{ mm}$, $N \leq 4$ It is shown in Fig.7.

Notes :

1. d_1 : Minimum distance between the broken and dot area
2. d_2 : The distance of burr from the edge of TFT/CF
3. W : Width
4. L : Length
5. D : Average Diameter
6. N : Count
7. All the angle of the broken must be larger than 90° . It is shown in Fig.8 ($R > 90^\circ$).
8. When the defect was spot by visual, it should be used the spec of spot.

Product Specification



Model: GKVGC1MNH1E0

Rev. No.

Issued Date.

Page.

A

2018/Jun/25

23 / 26

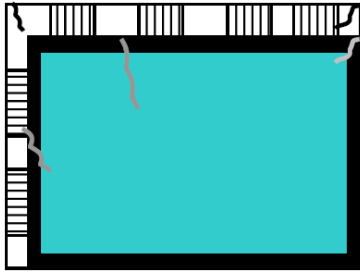

Fig 1

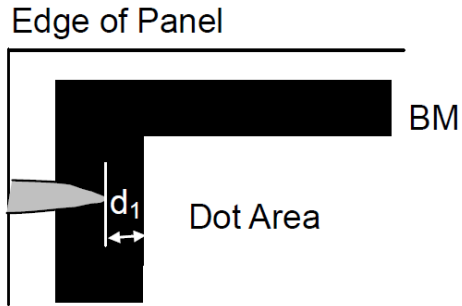

Fig 2

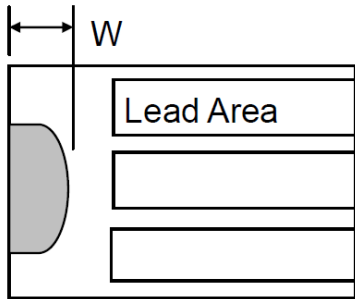

Fig 3

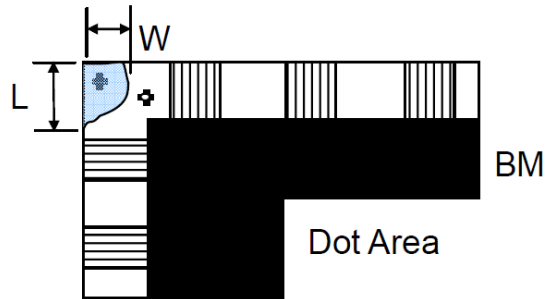

Fig 4

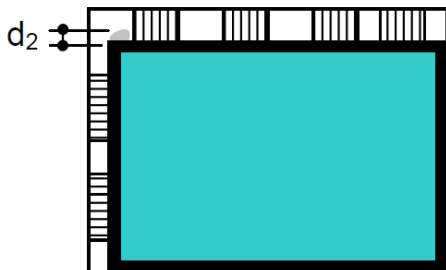

Fig 5

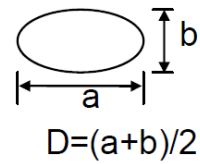

Fig 6

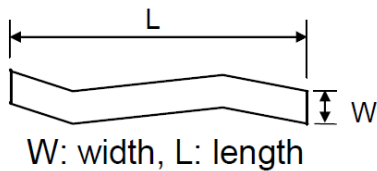

Fig 7

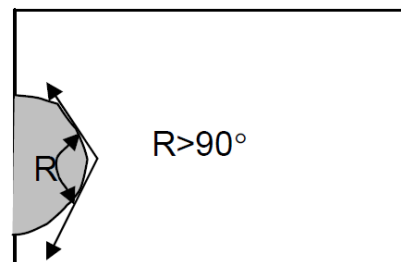



Fig 8

Product Specification

	Model: GKVGC1MNH1E0	Rev. No.	Issued Date.	Page.
		A	2018/Jun/25	24 / 26

10.4 Classification of defects

Inspection Item	Criteria and Description	Defect type
Vertical line	Signal input, vertical line off or irregular V-line appears	major
Horizontal line	Signal input, horizontal line off or irregular H-line appears	major
Cross line	Pattern signal input, a correct display is not obtained	major
No display	Signal input, display is dead	major
Irregular display	Pattern signal input, a correct display is not obtained	major
Dots defect	Exceed specified standards	minor
Scratch and Dent on polarizer	Exceed specified standards	minor
Foreign material	Exceed specified standards	minor
Mura	Not visible through 6% ND filter in 50% gray pattern. or judge by limit sample	minor
Polarizer bubble	Exceed specified standards	minor

10.5 Appearance inspection(Touch Panel)

(1) Scratch

Width	Length	Pitch	Criterion
$W \leq 0.05\text{mm}$	$L \leq 15\text{mm}$	---	Acceptable
$0.05\text{mm} < W \leq 0.1\text{mm}$	$L \leq 10\text{mm}$	5mm	Acceptable if such foreign objects are 4 or less
$0.1\text{mm} < W \leq 0.1\text{mm}$	$L \leq 10\text{mm}$	5mm	Acceptable if such foreign objects are 2 or less
$0.15\text{mm} < W$	$L > 10\text{mm}$	---	Unacceptable

(2) Granular foreign object

Diameter	Pitch	Criterion
$D \leq 0.2\text{mm}$	---	Acceptable
$0.2\text{mm} < D \leq 0.5\text{mm}$	5mm	Acceptable if such foreign objects are 5 or less
$0.5\text{mm} < D$	---	Unacceptable

Product Specification

	Model: GKVGC1MNHBE0	Rev. No.	Issued Date.	Page.
		A	2018/Jun/25	25 / 26

(3) Linear foreign object

Width	Length	Pitch	Criterion
$W \leq 0.05\text{mm}$	$L \leq 8\text{mm}$	---	Acceptable
$0.05\text{mm} < W \leq 0.1\text{mm}$	$L \leq 8\text{mm}$	5mm	Acceptable if such foreign objects are 4 or less
$0.1\text{mm} < W \leq 0.15\text{mm}$	$L \leq 8\text{mm}$	5mm	Acceptable if such foreign objects are 2 or less
$0.15\text{mm} < W$	$L > 8\text{mm}$	---	Unacceptable

(4) Bubble / Stain on film

Diameter	Pitch	Criterion
$D \leq 0.15\text{mm}$	---	Acceptable
$0.15\text{mm} < D \leq 0.25\text{mm}$	5mm	Acceptable if such foreign objects are 3 or less
$0.25\text{mm} < D \leq 0.4\text{mm}$	5mm	Acceptable if such foreign objects are 2 or less
$0.4\text{mm} < D \leq 0.6\text{mm}$	---	Acceptable if such foreign objects are 1 or less
$0.6\text{mm} < D$	---	Unacceptable

(5) Breakage on glass

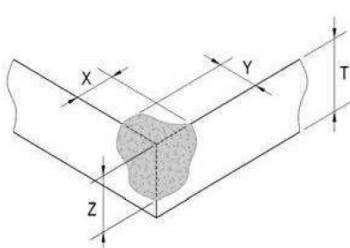
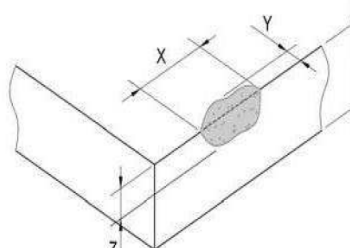
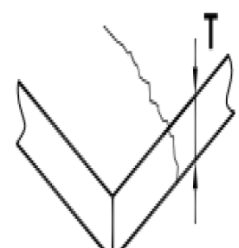
	Corner Fragment			Side Fragment			Crack
Judgment Criterion							
Unit : mm	X	Y	Z	X	Y	Z	Unacceptable
	$OK \leq 0.3$	$OK \leq 0.3$	$OK \leq 1/2T$	$OK \leq 0.3$	$OK \leq 0.3$	$OK \leq 1/2T$	

T : Thickness

If any value of "X", "Y" and "Z" is out of allowable range, it shall be regarded as defective.

(6) Printing Area (BM Area)

No.	Items	Spec.	Criterion
1	White / Dichroic speck	---	According to Granular foreign object spec.
2	Scratch	---	According to Scratch spec.

Product Specification



Model: GKVGC1MNHB1E0

Rev. No.

Issued Date.

Page.

A

2018/Jun/25

26 / 26

3	Pin Hole	$D \leq 0.15\text{mm}$	Acceptable
		$D > 0.15\text{mm}$	Unacceptable



Our company network supports you worldwide with offices in Germany, Austria, Switzerland, the UK and the USA. For more information please contact:

Headquarters

Germany



FORTEC Elektronik AG

Augsburger Str. 2b
82110 Germering

Phone: +49 89 894363-0
E-Mail: sales@fortecag.de
Internet: www.fortecag.de

Fortec Group Members

Austria



FORTEC Elektronik AG

Office Vienna
Nuschinggasse 12
1230 Wien

Phone: +43 1 8673492-0
E-Mail: office@fortec.at
Internet: www.fortec.at

Germany



Distec GmbH

Augsburger Str. 2b
82110 Germering

Phone: +49 89 894363-0
E-Mail: info@distec.de
Internet: www.distec.de



FORTEC Elektronik AG

Lechwiesenstraße 9
86899 Landsberg am Lech

Phone: +49 8191 91172-0
E-Mail: sales@fortecag.de
Internet: www.fortecag.de

Switzerland



ALTRAC AG

Bahnhofstraße 3
5436 Würenlos

Phone: +41 44 7446111
E-Mail: info@altrac.ch
Internet: www.altrac.ch

United Kingdom



Display Technology Ltd.

Osprey House, 1 Osprey Court
Hichingbrooke Business Park
Huntingdon, Cambridgeshire, PE29 6FN

Phone: +44 1480 411600
E-Mail: info@displaytechnology.co.uk
Internet: www.displaytechnology.co.uk

USA



Apollo Display Technologies, Corp.

87 Raynor Avenue,
Unit 1 Ronkonkoma,
NY 11779

Phone: +1 631 5804360
E-Mail: info@apolloDisplays.com
Internet: www.apolloDisplays.com