



 APOLLO DISPLAY
TECHNOLOGIES



 DISTEC



 DISPLAY
TECHNOLOGY



Manual

Advantech

MIO-2263

2.5" SBC with Intel® Atom™ E38258, Celeron® J1900



The information contained in this document has been carefully researched and is, to the best of our knowledge, accurate. However, we assume no liability for any product failures or damages, immediate or consequential, resulting from the use of the information provided herein. Our products are not intended for use in systems in which failures of product could result in personal injury. All trademarks mentioned herein are property of their respective owners. All specifications are subject to change without notice.

MIO-2263

Intel® Atom™ SoC J1900/E3825
Pico-ITX SBC, DDR3L, 18/24-bit
LVDS, VGA or HDMI, 1 GbE, Half-
size Mini PCIe, 4 USB, 2 COM,
SMBus, mSATA & MIOe

Copyright

The documentation and the software included with this product are copyrighted 2014 by Advantech Co., Ltd. All rights are reserved. Advantech Co., Ltd. reserves the right to make improvements in the products described in this manual at any time without notice.

No part of this manual may be reproduced, copied, translated or transmitted in any form or by any means without the prior written permission of Advantech Co., Ltd. Information provided in this manual is intended to be accurate and reliable. However, Advantech Co., Ltd. assumes no responsibility for its use, nor for any infringements of the rights of third parties, which may result from its use.

Acknowledgements

AMI is a trademark of AMI Software International, Inc.

Intel® is a trademark of Intel® Technologies, Inc.

IBM, PC/AT, PS/2 and VGA are trademarks of International Business Machines Corporation.

Intel and Atom® are trademarks of Intel Corporation.

Microsoft Windows® is a registered trademark of Microsoft Corp.

RTL is a trademark of Realtek Semi-Conductor Co., Ltd.

ESS is a trademark of ESS Technology, Inc.

UMC is a trademark of United Microelectronics Corporation.

SMI is a trademark of Silicon Motion, Inc.

Creative is a trademark of Creative Technology LTD.

All other product names or trademarks are properties of their respective owners.

Product Warranty (2 years)

Advantech warrants to you, the original purchaser, that each of its products will be free from defects in materials and workmanship for two years from the date of purchase.

This warranty does not apply to any products which have been repaired or altered by persons other than repair personnel authorized by Advantech, or which have been subject to misuse, abuse, accident or improper installation. Advantech assumes no liability under the terms of this warranty as a consequence of such events.

Because of Advantech's high quality-control standards and rigorous testing, most of our customers never need to use our repair service. If an Advantech product is defective, it will be repaired or replaced at no charge during the warranty period. For out-of-warranty repairs, you will be billed according to the cost of replacement materials, service time and freight. Please consult your dealer for more details.

If you think you have a defective product, follow these steps:

1. Collect all the information about the problem encountered. (For example, CPU speed, Advantech products used, other hardware and software used, etc.) Note anything abnormal and list any onscreen messages you get when the problem occurs.
2. Call your dealer and describe the problem. Please have your manual, product, and any helpful information readily available.
3. If your product is diagnosed as defective, obtain an RMA (return merchandise authorization) number from your dealer. This allows us to process your return more quickly.
4. Carefully pack the defective product, a fully-completed Repair and Replacement Order Card and a photocopy proof of purchase date (such as your sales receipt) in a shippable container. A product returned without proof of the purchase date is not eligible for warranty service.
5. Write the RMA number visibly on the outside of the package and ship it prepaid to your dealer.

Technical Support and Assistance

1. Visit the Advantech web site at www.advantech.com/support where you can find the latest information about the product.
2. Contact your distributor, sales representative, or Advantech's customer service center for technical support if you need additional assistance. Please have the following information ready before you call:
 - Product name and serial number
 - Description of your peripheral attachments
 - Description of your software (operating system, version, application software, etc.)
 - A complete description of the problem
 - The exact wording of any error messages

Packing List

Before installation, please ensure the following items have been shipped:

Item Part Number

- 1 MIO-2263 SBC
- 1 Startup manual
- Cables

Part Number	Description
1700006291	SATA cable 7P 30 cm w/ right angle
1700022444-01	Audio Cable 2*5P-2.0/JACK*2 20cm
1701200220	COM PORT cable 2*10P-2.0/D-SUB 9P(M)*2 22 cm
1700019656	SATA Power cable 5P-1.25/5P-2.0+SATA 5P 15 cm
1700002172	USB cable 2.0mm pitch USB-A(F) 17cm
1700019705	AT Power cable 12cm

- Heatsink:

1960063455T001	99.5 x 70.5 x 15.7 mm
----------------	-----------------------

- Stud & Screw

Part Number	Description
9666226300E	Stud and screw pack, including:
1935031500	Screw R/S D=5.3 H=2 + M3*15L, 4 pcs
1910002596-01	Stud F=M3*10L M=M3*5L B=5 H=19, 4 pcs
193B0204C0	Screw F/S D=3.5 H=0.8 + M2*4L, 2 pcs

Ordering Information

Model Number	Description
MIO-2263J-U0A1E	Intel® Atom™ SoC J1900, fanless, LVDS, VGA, Gigabit Ethernet, 4 USB, mSATA, SMBus, GPIO, 2 COM, mini PCIe, MIOe
MIO-2263JH-U0A1E	Intel® Atom™ SoC J1900, fanless, LVDS, HDMI, Gigabit Ethernet, 4 USB, mSATA, SMBus, GPIO, 2 COM, mini PCIe, MIOe
MIO-2263E-S3A1E	Intel Atom SoC E3825, fanless, LVDS, VGA, Gigabit Ethernet, 4 USB, mSATA, SMBus, GPIO, 2 COM, mini PCIe, MIOe

Optional Accessories

Part No.	Description
1960065074N001	Heat Spreader (99.5 x 70.5 x 11.2 mm)

Declaration of Conformity

This device complies with the requirements in part 15 of the FCC rules: Operation is subject to the following two conditions:

1. This device may not cause harmful interference, and
2. This device must accept any interference received, including interference that may cause undesired operation

FCC Class A

This equipment has been tested and found to comply with the limits for a Class A digital device, pursuant to Part 15 of the FCC Rules. These limits are designed to provide reasonable protection against harmful interference when the equipment is operated in a commercial environment. This equipment generates, uses, and can radiate radio frequency energy and, if not installed and used in accordance with the instruction manual, may cause harmful interference to radio communications. Operation of this device in a residential area is likely to cause harmful interference in which case the user will be required to correct the interference at his/her own expense. The user is advised that any equipment changes or modifications not expressly approved by the party responsible for compliance would void the compliance to FCC regulations and therefore, the user's authority to operate the equipment.

Caution! *There is a danger of a new battery exploding if it is incorrectly installed. Do not attempt to recharge, force open, or heat the battery. Replace the battery only with the same or equivalent type recommended by the manufacturer. Discard used batteries according to the manufacturer's instructions.*



Safety Instructions

1. Read these safety instructions carefully.
2. Keep this User Manual for later reference.
3. Disconnect this equipment from any AC outlet before cleaning. Use a damp cloth. Do not use liquid or spray detergents for cleaning.
4. For plug-in equipment, the power outlet socket must be located near the equipment and must be easily accessible.
5. Keep this equipment away from humidity.
6. Put this equipment on a reliable surface during installation. Dropping it or letting it fall may cause damage.
7. The openings on the enclosure are for air convection. Protect the equipment from overheating. **DO NOT COVER THE OPENINGS.**
8. Make sure the voltage of the power source is correct before connecting the equipment to the power outlet.
9. Position the power cord so that people cannot step on it. Do not place anything over the power cord.
10. All cautions and warnings on the equipment should be noted.
11. If the equipment is not used for a long time, disconnect it from the power source to avoid damage by transient overvoltage.
12. Never pour any liquid into an opening. This may cause fire or electrical shock.
13. Never open the equipment. For safety reasons, the equipment should be opened only by qualified service personnel.
14. If one of the following situations arises, get the equipment checked by service personnel:
 - The power cord or plug is damaged.
 - Liquid has penetrated into the equipment.
 - The equipment has been exposed to moisture.
 - The equipment does not work well, or you cannot get it to work according to the user's manual.
 - The equipment has been dropped and damaged.
 - The equipment has obvious signs of breakage.
15. **DO NOT LEAVE THIS EQUIPMENT IN AN ENVIRONMENT WHERE THE STORAGE TEMPERATURE MAY GO BELOW -20° C (-4° F) OR ABOVE 60° C (140° F). THIS COULD DAMAGE THE EQUIPMENT. THE EQUIPMENT SHOULD BE IN A CONTROLLED ENVIRONMENT.**
16. **CAUTION: DANGER OF EXPLOSION IF BATTERY IS INCORRECTLY REPLACED. REPLACE ONLY WITH THE SAME OR EQUIVALENT TYPE RECOMMENDED BY THE MANUFACTURER, DISCARD USED BATTERIES ACCORDING TO THE MANUFACTURER'S INSTRUCTIONS.**

The sound pressure level at the operator's position according to IEC 704-1:1982 is no more than 70 dB (A).

DISCLAIMER: This set of instructions is given according to IEC 704-1. Advantech disclaims all responsibility for the accuracy of any statements contained herein.

Safety Precaution - Static Electricity

Follow these simple precautions to protect yourself from harm and the products from damage.

- To avoid electrical shock, always disconnect the power from your PC chassis before you work on it. Don't touch any components on the CPU card or other cards while the PC is on.
- Disconnect power before making any configuration changes. The sudden rush of power as you connect a jumper or install a card may damage sensitive electronic components.

Contents

Chapter 1	General Introduction	1
1.1	Introduction	2
1.2	Specifications	2
1.2.1	General Specifications	2
1.2.2	Functional Specifications	3
1.2.3	Mechanical Specifications	4
1.2.4	Electrical Specifications	4
1.2.5	Environmental Specifications	5
1.3	Function Block Diagram	5
Chapter 2	H/W Installation.....	7
2.1	Jumpers	8
2.1.1	Jumper Description	8
2.1.2	Jumper List	8
	Table 2.1: Jumper List	8
2.1.3	Jumper Settings	8
	Table 2.2: J1: LCD Power/Auto Power on	8
2.2	Connectors	9
2.2.1	Connector List	9
2.2.2	Connector Settings	9
2.3	Mechanical	12
2.3.1	Jumper and Connector Locations	12
	Figure 2.1 Jumper and Connector layout (Top side)	12
	Figure 2.2 Jumper and connector layout (Bottom side)	12
2.3.2	Board Dimensions	13
	Figure 2.3 Board dimension layout (Top side)	13
	Figure 2.4 Board dimension layout (Bottom side)	13
	Figure 2.5 Board dimension layout (coastline with power connector and heatsink)	14
	Figure 2.6 Board dimension layout (coastline with Power connector and optional heatspreader)	14
	Figure 2.7 Board dimension layout (coastline with optional DC/jack)	14
	Figure 2.8 MIO module height constraints	15
	Figure 2.9 Illustration of heat spreader assembly	16
Chapter 3	BIOS Settings.....	17
3.1	BIOS Setup	18
3.2	Entering Setup	19
3.2.1	Main Setup	19
3.2.2	Advanced BIOS Features Setup	20
3.2.3	Chipset Configuration	34
3.2.4	Security	43
3.2.5	Boot	44
3.2.6	Save & Exit	45
Chapter 4	S/W Introduction & Installation	47
4.1	S/W Introduction	48
4.2	Driver Installation	48

	4.2.1	Windows 7 Professional	48
	4.2.2	Other OS.....	48
4.3		Value-Added Software Services	48
	4.3.1	SUSI Introduction.....	48
	4.3.2	Software APIs	49
	4.3.3	SUSI Installation	50
	4.3.4	SUSI Sample Programs.....	51

Appendix A PIN Assignments 59

A.1	Jumper Setting.....	60
	Table A.1: Jumper List.....	60
A.2	Connectors.....	60
	Table A.2: Connectors	60
	Table A.3: J1: LCD Power/Auto Power On.....	60

Appendix B WDT & GPIO 81

B.1	Watchdog Timer Sample Code.....	82
B.2	GPIO Sample Code	83

Appendix C System Assignments..... 85

C.1	System I/O Ports.....	86
	Table C.1: System I/O Ports	86
C.2	1st MB Memory Map.....	86
	Table C.2: 1st MB Memory Map	86
C.3	Interrupt Assignments	87
	Table C.3: Interrupt assignments.....	87

Chapter 1

General Introduction

This chapter gives background information on the MIO-2263.

Sections include:

- Introduction
- Product Features
- Specifications

1.1 Introduction

MIO-2263 is a MI/O-Ultra SBC (Single Board Computer) with Embedded Intel® Atom™ SoC J1900 2.0 GHz and E3825 1.33 GHz Processor. The MIO-2263 can support DDR3L memory up to 8 GB, has one USB 3.0 and 3 USB2.0 compatible ports, one GbE (up to 1000 Mbps) interface, LVDS and VGA or HDMI support, HD (High Definition) audio, and one half size mini-PCIe and MIOe expansion slot. In addition, MIO-2263 also supports one SATA drive, two COM ports, SMBus, one GPIO and one half size mSATA slot. Advantech's innovative MI/O (multiple I/O) Extension SBC is equipped with flexible multiple I/O to assist integrators in developing optimized solutions.

1.2 Specifications

1.2.1 General Specifications

- **CPU:** Intel® Atom™ SoC processor J1900/ E3825
- **System Chipset** Intel® Atom™ SoC J1900/ E3825
- **BIOS:** AMI EFI 64 Mbit Flash BIOS
- **System Memory:** DDR3L, 1333 MHz for J1900, 1066 MHz for E3825, up to 8 GB
- **Watchdog Timer:** Single chip Watchdog 255-level interval timer, setup by software
- **Expansion Interface:**
 - 1 x half size mini-PCIe slot
 - 1 x MIOe connector: supports 2 x USB 2.0, 2 x PCIe x1, LPC, HD Audio line-out, SMBus, DP (or HDMI, supported by request), 5 Vsb/12 Vsb power
- **Battery:** Lithium 3 V / 210 mAH

I/O

- **Internal I/O interface:** 2 x USB2.0, 1 x RS-232, 1 x RS-232/422/485, 1 x HD Audio (line in, line out), GPIO, SMBus
- **Rear I/O ports:** 1 x RJ45 Ethernet, 1 x VGA or HDMI, 1 x USB 3.0, 1 x USB 2.0, 1 x Power connector (or DC jack, supported by request):

Ethernet

- **Controller:** Intel i210 (GbE1)
- **Speed:** 10/100/1000 Mbps
- **Connector:** 1 x RJ45
- **Standard:** Compliant with IEEE 802.3, IEEE 802.3u, IEEE 802.3z, IEEE 802.ab
- Support wake-on-LAN

Display

- **Controller:** Intel® Atom™ SoC J1900/ E3825, Directx* 11 and OpenGL 3.0 support
- **Resolution:**
 - VGA: 1920 x 1200
 - LVDS: 18/24-bit LVDS1, up to 1440 x 900
 - HDMI: 1920 x 1080

1.2.2 Functional Specifications

Processor

Processor	<ul style="list-style-type: none"> ■ Intel® Atom™ SoC Processor J1900/ E3825 ■ Frequency <ul style="list-style-type: none"> – J1900 2.0 GHz/ CPU Burst 2.42 GHz – E3825 1.33 GHz ■ Manufacturing Technology: 22 nm ■ L2 cache: 2 MB (J1900)/ 1 MB (E3825)
Memory	<ul style="list-style-type: none"> ■ Supports DDR3L, 1333 MHz (J1900), DDR3L 1066 MHz (E3825), up to 8 GB ■ SODIMM Socket: 204-pin SODIMM socket type *1
Graphic Engine	<ul style="list-style-type: none"> ■ Directx* 11, OGL 3.0, OCL 1.1, OGL ES 2.0 ■ Hardware decode/ acceleration: <ul style="list-style-type: none"> – Encode: H264, MPEG2/4, VC1, WMV9 – Decode: H264, MPEG2
Display	<ul style="list-style-type: none"> ■ VGA: 1920 x 1200 @ 60 Hz ■ HDMI: 1920 x 1080 ■ LVDS1: 18/24-bit, up to 1440 x 900 @ 60 Hz ■ Dual independent display: LVDS + VGA or HDMI + LVDS

Chipset

Control Hub	<ul style="list-style-type: none"> ■ Intel® Atom SoC processor J1900/ E3825
Audio	<ul style="list-style-type: none"> ■ High Definition Audio (HD) ALC-888S codec ■ Up to 2 channel of PCM (Pulse Code Modulation) audio output ■ Connectors: Line-out, Line-in
PCI-Express Interface	<ul style="list-style-type: none"> ■ 4 PCI-Express x1 Lanes ■ Lane 1 & 2 : MIOe connector ■ Lane 3: Half-size Mini PCIe connector ■ Lane 4: Intel i210 GbE controller
SATA Interface	<ul style="list-style-type: none"> ■ 1 x mSATA by mini-PCIe socket ■ 1 x SATAII (Max. Data transfer Rate 300 MB/s)
USB Interface	<ul style="list-style-type: none"> ■ 2 x internal USB ports ■ 2 x rear I/O ports at coastline (one USB 2.0 + one USB 3.0) ■ Transmission speed up to 480 Mbps (USB 2.0) / 5 Gbps (USB 3.0)
Power Management	<ul style="list-style-type: none"> ■ Full ACPI (Advanced Configuration and Power Interface) 3.0 ■ Supports S0, S3, S4, S5 ■ Support wake on LAN
BIOS	AMI EFI 64 Mbit Flash BIOS via SPI

Others

Ethernet	<ul style="list-style-type: none">■ Controller: Intel® i210 (GbE1)■ Compliant with IEEE 802.3, IEEE 802.3u, IEEE 802.3z, IEEE 802.ab■ Support 10/100/1000 Mbps■ Connectors: RJ45■ LAN1 LED<ul style="list-style-type: none">– Link: Green (100Mbps)/ Orange (1000Mbps)– Active: Green (flash)■ Support wake on LAN
Serial ports	<ul style="list-style-type: none">■ Controller: SMSC SCH 3114■ 1 x RS-232 / 1 x 232/422/485 serial ports with ESD protection: air gap ± 15 kV, contact ± 8 kV
GPIO	<ul style="list-style-type: none">■ Controller: SMSC SCH 3114■ 8-Bit (programming) through Super I/O, pin header■ 5 V tolerance
SMBus	Default is SMBus

1.2.3 Mechanical Specifications

1.2.3.1 Dimensions (mm)

L100 mm x W72 mm (3.9" x 2.8")

1.2.3.2 Height on top (mm)

15.7 mm (Heatsink)

1.2.3.3 Height under bottom (mm)

16.34 mm (Rear I/O USB)

1.2.3.4 Weight (g)

0.46 kg (1.01 lb, weight of total package)

1.2.4 Electrical Specifications

Power Supply Type: Single 12 V DC power input (support DC power hot plug)

1.2.4.1 Power supply Voltage

- Single 12 V input $\pm 10\%$
- Total peripheral power supply output: 5 V @ 3 A for CPU board and MIOe module totally, 12 V @ 2 A for MIOe module

1.2.4.2 Power Consumption

- **Typical in Windows 8 Idle Mode:**
 - J1900: 0.85 A @ 12 V (10.2 W)
 - E3825: 0.59 A @ 12 V (7.08 W)
- **Max in Windows 8 HCT12 (10 minutes):**
 - J1900: 1.04 A @ 12 V (12.48 W)
 - E3825: 0.76 A @ 12 V (9.12 W)

1.2.4.3 RTC Battery

- **Typical Voltage:** 3.0 V
- **Normal discharge capacity:** 210 mAh

1.2.5 Environmental Specifications

1.2.5.1 Operating Humidity

40 °C @ 95% RH Non-Condensing

1.2.5.2 Operating Temperature

0 ~ 60 °C (32~140 °F)

1.2.5.3 Storage Humidity

60 °C @ 95% RH Non-Condensing

1.2.5.4 Storage Temperature

-40 ~ 85 °C (-40 ~ 185 °F)

1.3 Function Block Diagram

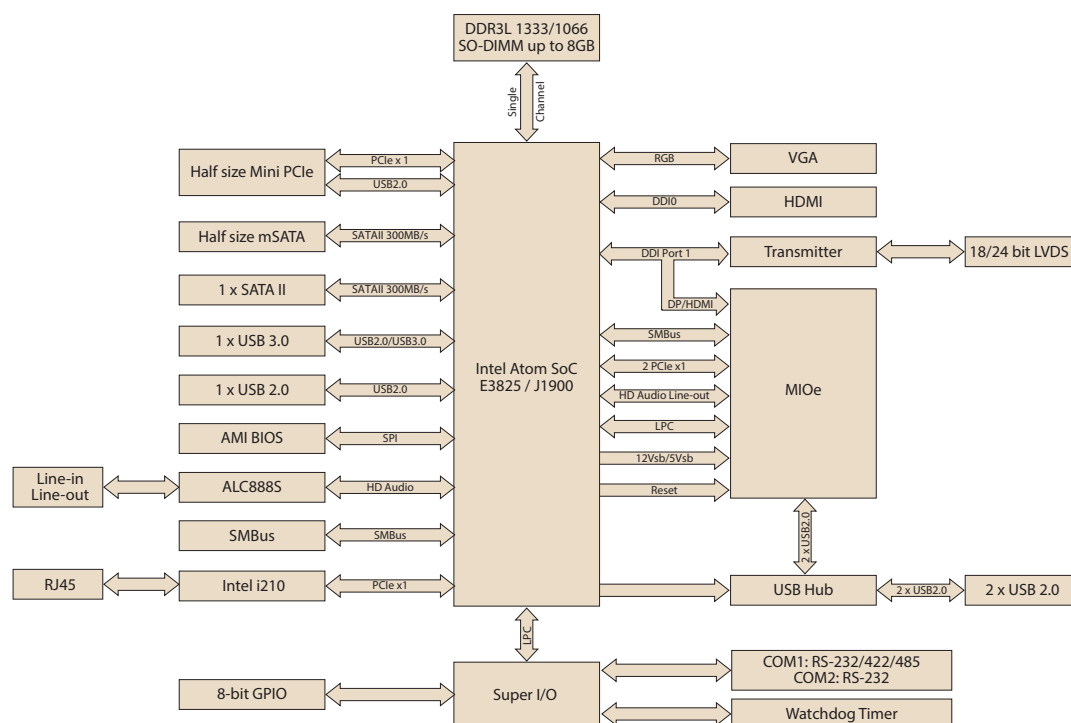

Chapter 2

H/W Installation

This chapter explains the setup procedures of the MIO-2263 hardware, including instructions on setting jumpers and connecting peripherals, as well as switches, indicators and mechanical drawings. Be sure to read all safety precautions before you begin the installation procedure.

2.1 Jumpers

2.1.1 Jumper Description

Cards can be configured by setting jumpers. A jumper is a metal bridge used to close an electric circuit. It consists of two metal pins and a small metal clip (often protected by a plastic cover) that slides over the pins to connect them. To close a jumper, you connect the pins with the clip. To open a jumper, you remove the clip. Sometimes a jumper will have three pins, labeled 1, 2 and 3. In this case you would connect either pins 1 and 2, or 2 and 3.

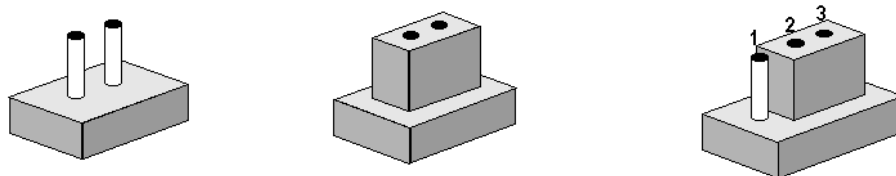

The jumper settings are schematically depicted in this manual as follows.



A pair of needle-nose pliers may be helpful when working with jumpers. If you have any doubts about the best hardware configuration for your application, contact your local distributor or sales representative before you make any changes.

Generally, you simply need a standard cable to make most connections.

Warning! To avoid damaging the computer, always turn off the power supply before setting jumpers.



2.1.2 Jumper List

Table 2.1: Jumper List

J1	LCD Power / Auto Power on
----	---------------------------

2.1.3 Jumper Settings

Table 2.2: J1: LCD Power/Auto Power on

Part Number	1653003260
Footprint	HD_3x2P_79
Description	PIN HEADER 3*2P 180D(M) 2.0mm SMD SQUARE PIN
Setting	Function
(1-2)	+5V
(3-4) (default)	+3.3V
(5-6) (default)	Auto Power On

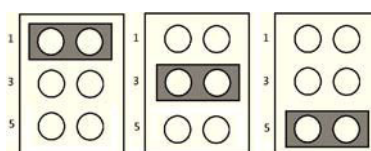

2.2 Connectors

2.2.1 Connector List

CN1	12 V Power Input
CN2	DC JACK (by request)
CN3	12 V Power Input (2 x 3 pin support by request)
CN6	DDR3 SO-DIMM
CN9	GPIO
CN11	VGA
CN12	HDMI
CN13	Front Panel
CN14	SATA
CN15	mSATA
CN16	Mini PCIe
CN18	Internal USB
CN19	External USB 3.0 + USB 2.0
CN20	COM1/COM2
CN24	Gigabit Ethernet
CN27	HD Audio
CN29	MIOe
CN30	Inverter Power/Internal SATA Power
CN31	18/24 bits LVDS Panel
CN33	SMBus
BH1	Battery

2.2.2 Connector Settings

2.2.2.1 Battery Connector (BH1)

MIO-2263 supports Lithium 3 V/210 mAH CR2032 battery with wire via battery connector (BH1).

Note! How to clear CMOS: (Must follow below steps)



1. Turn off system power
2. Unplug CR2032 battery cable on BH1
3. Waiting for 15sec or short BH1 pin1-2
4. Connect battery cable on BH1
5. Turn on system power

2.2.2.2 12 V Power Input Connector (CN1)

Main power connector supports single 12 V input, and there's an optional choice of **DC/Jack (CN2, co-layout with 2pin power connector)**

2.2.2.3 DDRIII SODIMM Socket (CN6)

One 204-pin/H9.2 mm DDRIII DIMM socket supports DDR3L 1333 MHz (J1900)/1066 MHz (E3825) up to 8 GB.

2.2.2.4 GPIO (General Purpose Input Output) (CN9)

The board supports 8-bit GPIO (5 V tolerance) through GPIO pin header. The 8 digital inputs and outputs can be programmed to read or control devices, with each input or output defined.

2.2.2.5 VGA/ HDMI/ LVDS Interface Connections (CN11/ CN12/ CN31)

The MIO-2263's display interface support either VGA or HDMI on rear IO and is capable of driving a wide range of flat panel displays, including passive LCD and active LCD displays. The board has three kinds of connector types to support these displays: one is on rear IO support either standard CRT VGA monitors or high definition HDMI display and one for LVDS type LCD panels.

CRT display connector (CN11)

The CRT display 15pins connector is a rear I/O connector on coastline used for conventional CRT displays. Resolution: up to 1920 x 1200.

HDMI display connector (CN12)

MIO-2263 also support HDMI display output, meet HDMI1.4a specification. Resolution: up to 1920 x 1080.

LVDS LCD panel connector (CN31)

The board supports single channel 18/24-bit LVDS LCD panel displays via 14*1pin wafer box. Resolution: up to 1400 x 900.

2.2.2.6 Front Panel Connector(CN13)

MIO-2263 integrates below functions as front panel 6pin connector.

Power button

Supports power on/off button in ATX mode.

Reset

If you install a reset switch, it should be an open single pole switch. Momentarily pressing the switch will activate a reset.

Power LED

Power LED indicator would light when power is on.

HDD LED

HDD LED indicator for hard disk access is an active low signal

2.2.2.7 SATA Connector (CN14)

MIO-2263 features one high performance Serial ATA interfaces. Data transfer rates up to 300 MB/s enabling very fast data and file transfer, and independent DMA operation on two ports.

2.2.2.8 mSATA Connector (CN15)

MIO-2263 provides a half size mini-PCIe socket which integrates SATAII signals, supports mSATA interface modules.

2.2.2.9 Mini PCIe Connector (CN16)

MIO-2263 supports a half size mini PCIe slot. PCI Express Mini Card (also known as Mini PCI Express, Mini PCIe, and Mini PCI-E) is a replacement for the Mini PCI form factor based on PCI Express. It is developed by the PCI-SIG. The host device supports both PCI Express and USB 2.0 connectivity.

2.2.2.10 USB Connectors (CN18 and CN19)

The board provides four USB (Universal Serial Bus) ports, two are rear I/O on coastline (CN19); and the other two are internal USB ports (CN18). The rear I/O USB port support one USB 3.0 port and one USB 2.0. The USB 3.0 port comply with USB

specification Rev. 3.0 which supports 5.0 Gbps transfer rate and backward compatible with USB 2.0 device. This gives complete Plug and Play, and hot attach/detach for up to 127 external devices. Other USB interfaces comply with USB specification Rev. 2.0 which supports 480 Mbps transfer rate and are fuse protected.

2.2.2.11 COM Port Connectors (CN20)

MIO-2263 provides two serial ports in 10 x 2pin pin header. COM2 is for RS-232 and COM1 is for RS-232/422/485 functionality. It provides connections for serial devices or a communication network. The pin assignments for the COM port connector can be found in Appendix.

2.2.2.12 Gigabit Ethernet Connector (CN24)

MIO-2263 uses Intel® i210 Ethernet chip (10/100/1000 Mbps) linked to dedicated PCIe x1 lane via RJ-45 connector.

2.2.2.13 High Definition Audio Interface (CN27)

MIO-2263 provides one 5 x 2 pin box header for audio device. It can support high definition audio stereo by customized audio module that has codec onboard.

2.2.2.14 MIOe connector (CN29)

MIO-2263 supports MIOe connector to extend flexible I/Os.

Interface

2 x USB 2.0, 2 x PCIe x1, LPC, HD Audio line-out, SMBus, DP (or HDMI, supported by request), 5 Vsb/12 Vsb power.

Total peripheral power supply output

5 V @ 3 A for CPU board and MI/O Extension module totally, 12 V @ 2 A for MI/O Extension module.

2.2.2.15 Inverter Power/Internal SATA Power Connector (CN30)

The LCD inverter is connected to CN30 via a 5-pin connector to provide +5 V/+12 V power to the LCD display, and 5V power can be provided for 2.5" SATA HDD via CN30.

SATA power's current is only sufficient for 2.5" HDD, and LVDS inverter's current is 5 V @ less than 1 A, 12 V @ 500 mA.

2.2.2.16 SMBus Connector (CN33)

MIO-2263 provides SMBus connector for customer connection to SMBus protocol embedded device.

Advantech also provide SMBus API allowing developers to interface with an embedded system environment and transfer serial messages using the SMBus protocols, allowing multiple simultaneous device control.

2.3 Mechanical

2.3.1 Jumper and Connector Locations

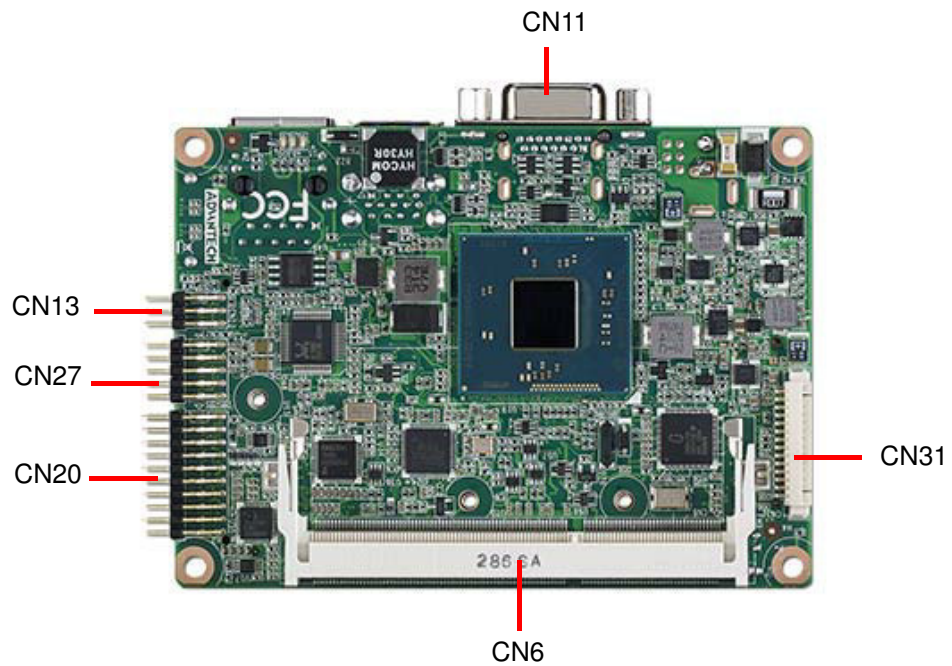

Figure 2.1 Jumper and Connector layout (Top side)

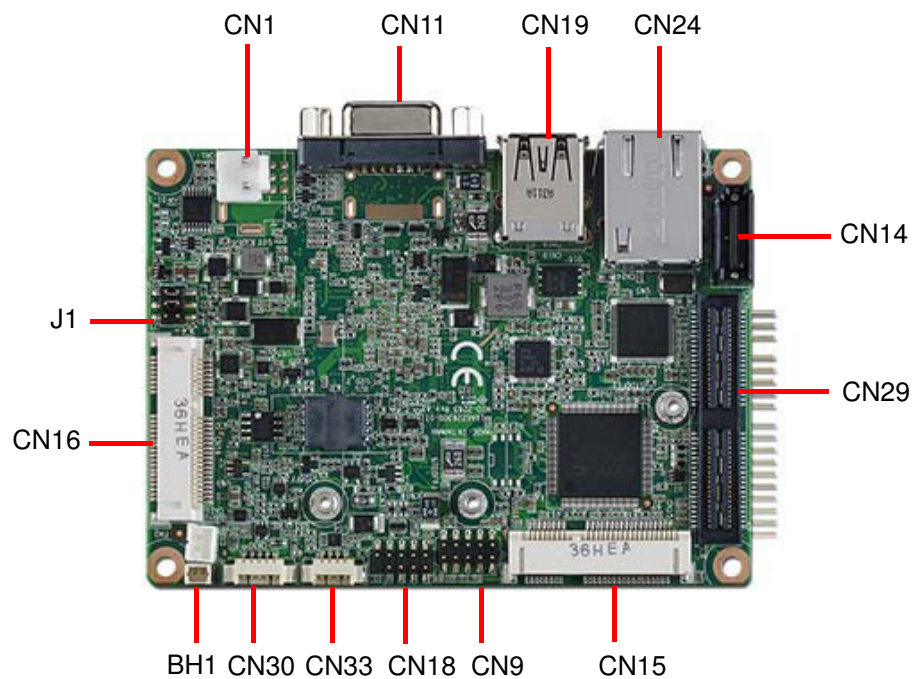

Figure 2.2 Jumper and connector layout (Bottom side)

2.3.2 Board Dimensions

2.3.2.1 CPU Board Drawing

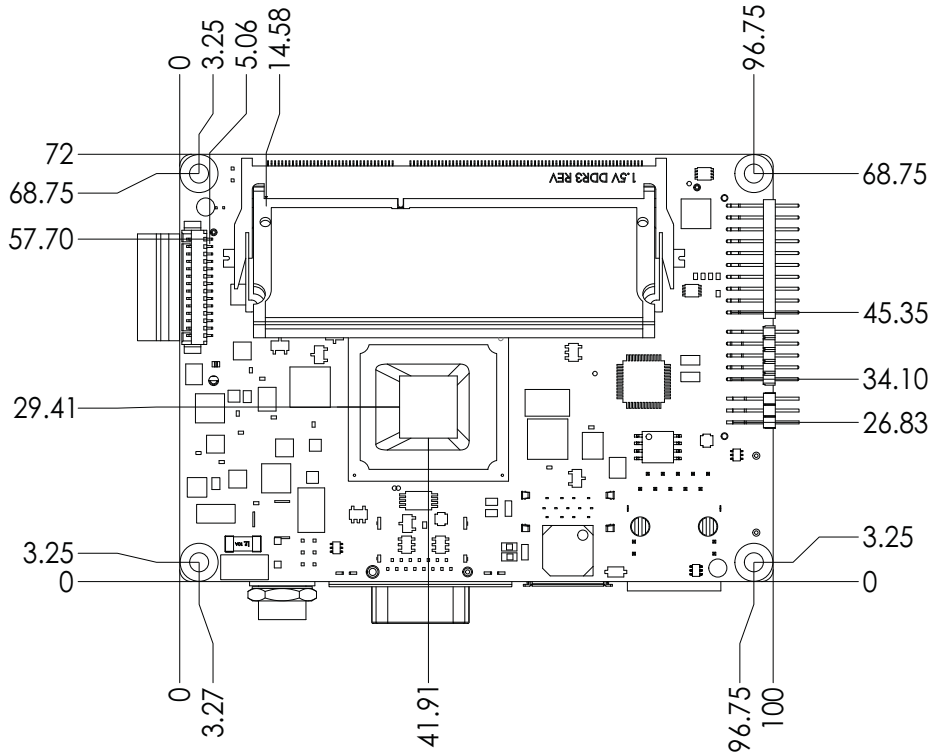

Figure 2.3 Board dimension layout (Top side)

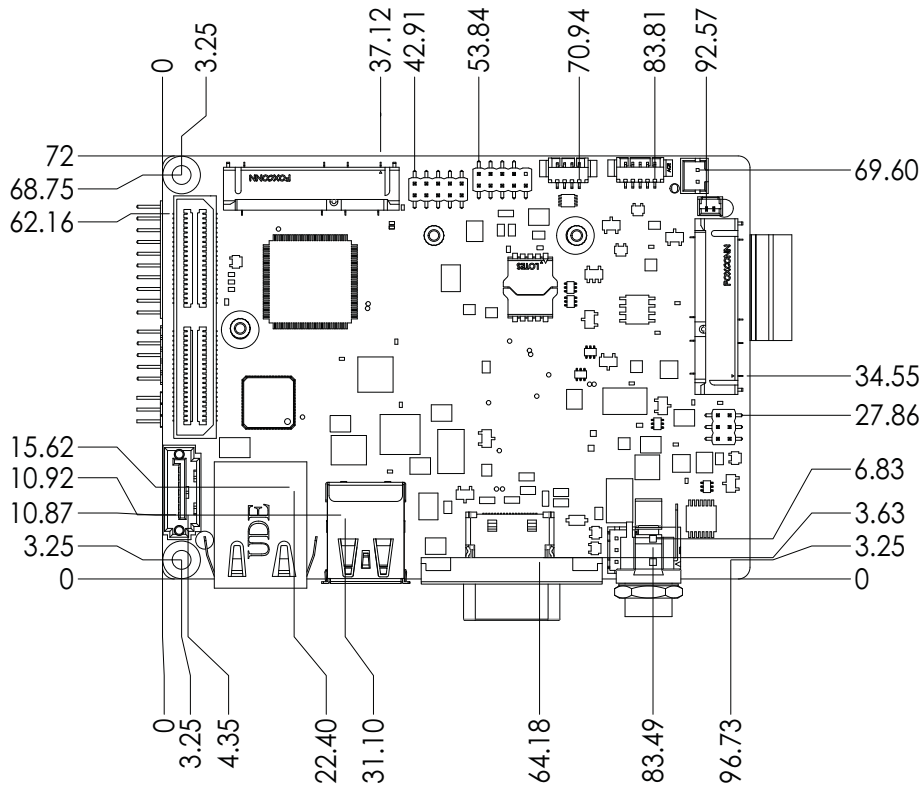

Figure 2.4 Board dimension layout (Bottom side)

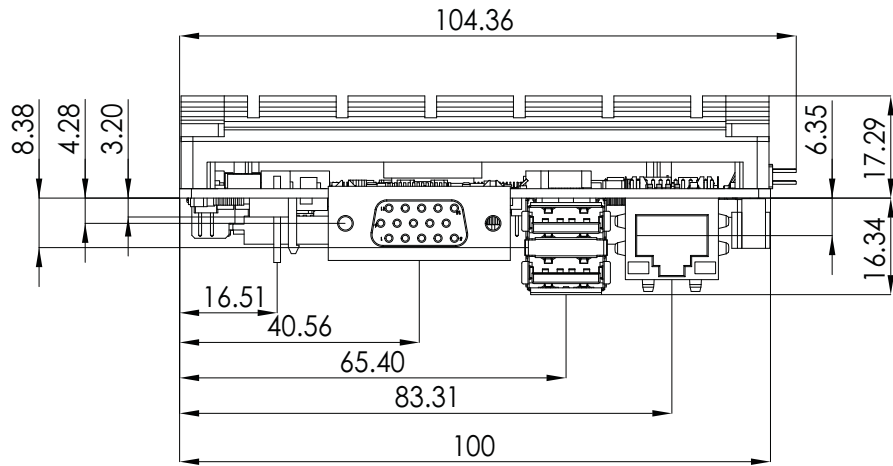

Figure 2.5 Board dimension layout (coastline with power connector and heatsink)

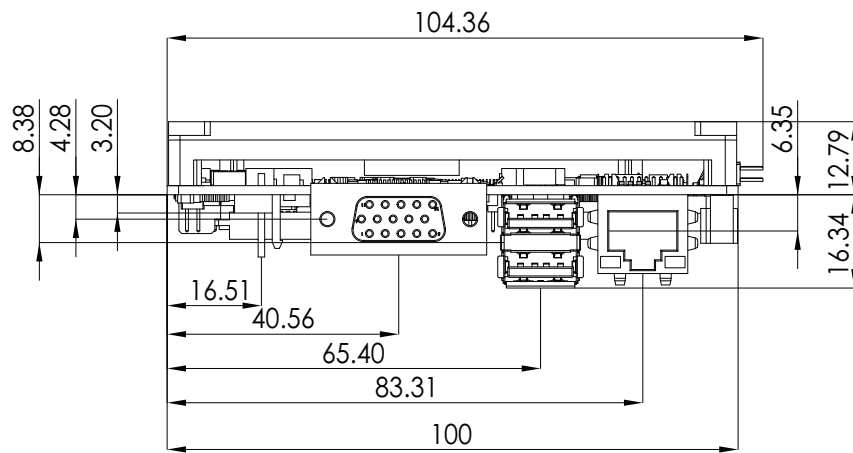

Figure 2.6 Board dimension layout (coastline with Power connector and optional heatspreader)

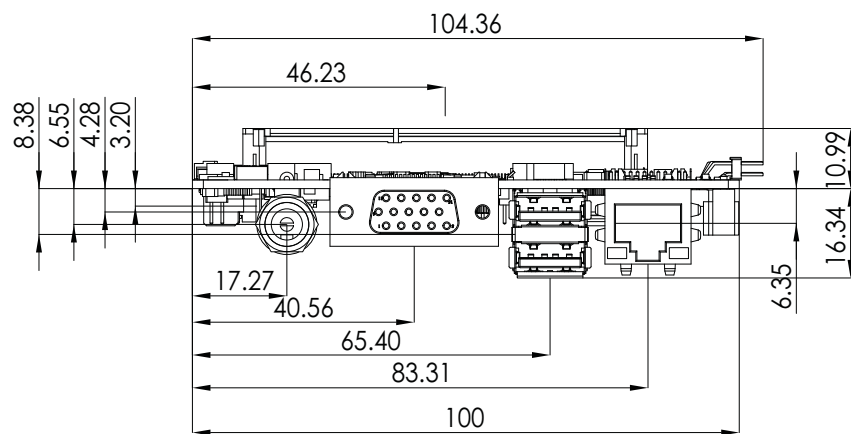

Figure 2.7 Board dimension layout (coastline with optional DC/jack)

2.3.2.2 MI/O Module Height Constraint

To avoid mechanical conflict with MI/O-Ultra CPU board, it's recommended to refer to the following drawing for MI/O module height constraints.

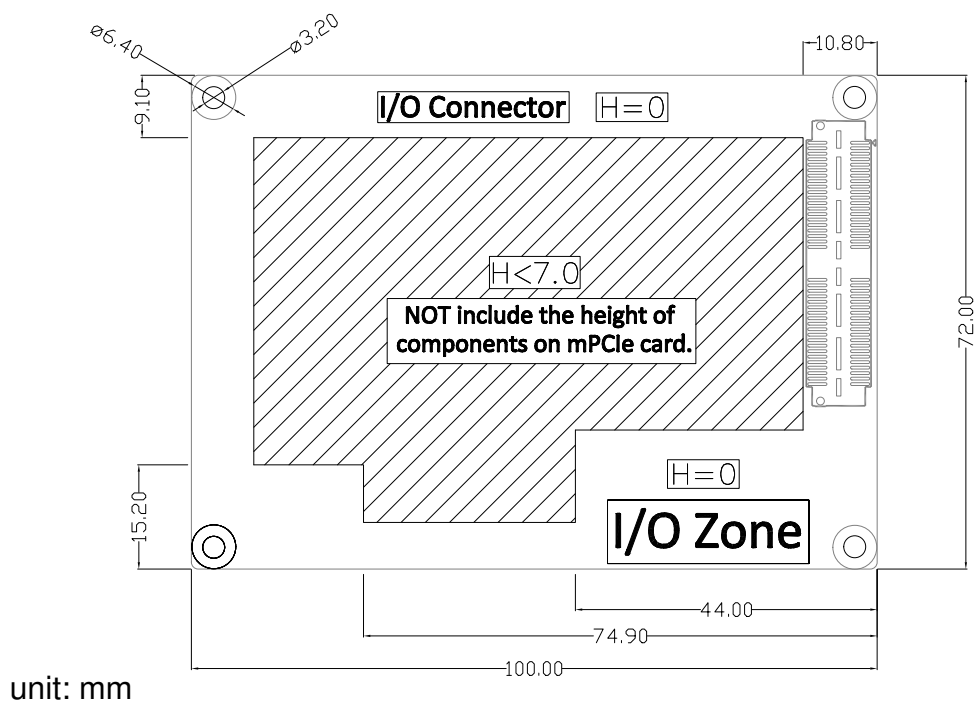

Figure 2.8 MI/O module height constraints

- Note!**
1. Constraint of components' max. height of MI/O module base on 16 mm height MIOe connector. If needed, there's a 19 mm height connector as well.
 2. The height of power connector (including of cable) on MIO-2263 should be considered when assembling the system or stacking the MI/O module.



2.3.2.3 Another Thermal Solution - Heat Spreader

MIO-2263 has an optional heat spreader to make whole system more compact. Using a heat spreader to conduct heat to your chassis can help a lot when the system is extra compact or has limited space for heat convection. Here are some guidelines for the heat spreader:

1. For best heat conduction, the gap between the chassis and heat spreader should be smaller, the smaller the better.
2. The height of the existing heat spreader is 11.2mm (Advantech P/N: 1960065074N001). If you need some other height to fit the chassis better, Advantech can customize it for you. (Please contact our sales for details)
3. Thermal grease and screws are provided in heat spreader kit, thermal grease helps conduct better if the chassis is quite close to heat spreader. Another suggestion is to use a thermal pad if the chassis isn't close enough to the heat spreader. (The gap should be less than 3mm for better heat conduction)

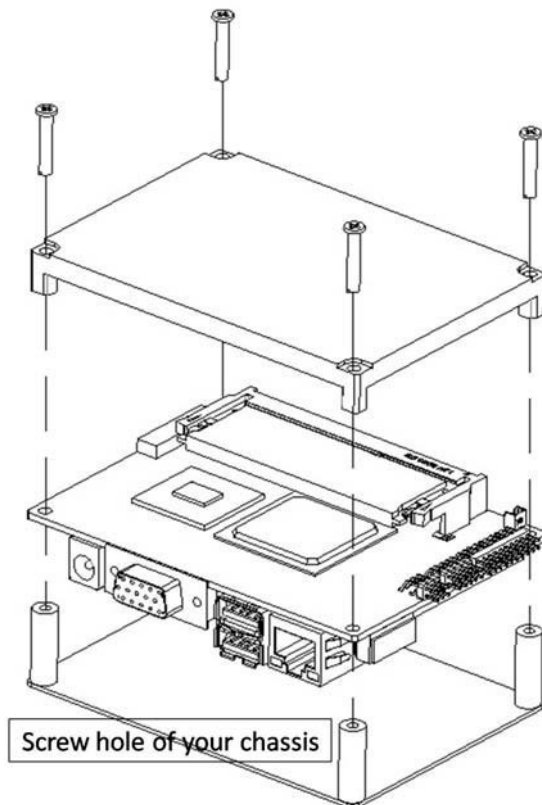

Figure 2.9 Illustration of heat spreader assembly

Chapter 3

BIOS Settings

3.1 BIOS Setup

AMIBIOS has been integrated into many motherboards for over a decade. With the AMIBIOS Setup program, users can modify BIOS settings and control various system features. This chapter describes the basic navigation of the MIO-2263 BIOS setup screens.

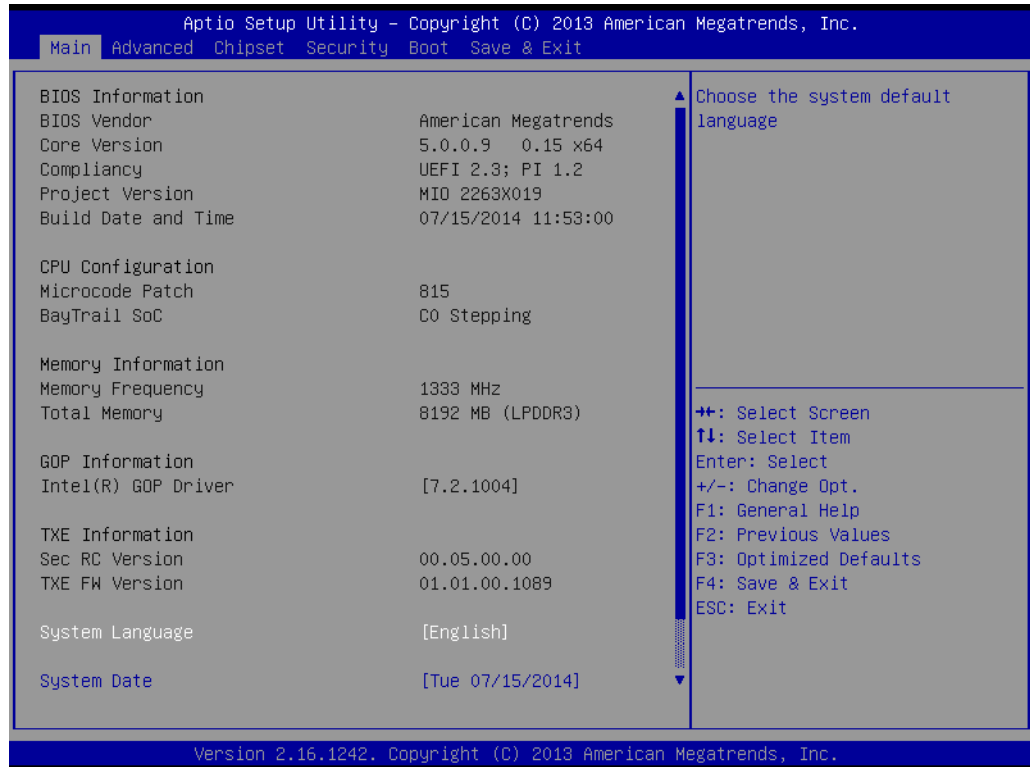

AMI's BIOS ROM has a built-in Setup program that allows users to modify the basic system configuration. This information is stored in flash ROM so it retains the Setup information when the power is turned off.

Note! *Default BIOS is supported for 64 bit OS installation, BIOS for 32 bit OS is supported by project, please contact with sales representative for details.*



3.2 Entering Setup

Turn on the computer and check for the -patch" code. If there is a number assigned to the patch code, it means that the BIOS supports your CPU. If there is no number assigned to the patch code, please contact an Advantech application engineer to obtain an up-to-date patch code file. This will ensure that your CPU's system status is valid. After ensuring that you have a number assigned to the patch code, press and you will immediately be allowed to enter Setup.

3.2.1 Main Setup

When users first enter the BIOS Setup Utility, users will enter the Main setup screen. Users can always return to the Main setup screen by selecting the Main tab. There are two Main Setup options. They are described in this section. The Main BIOS Setup screen is shown below.

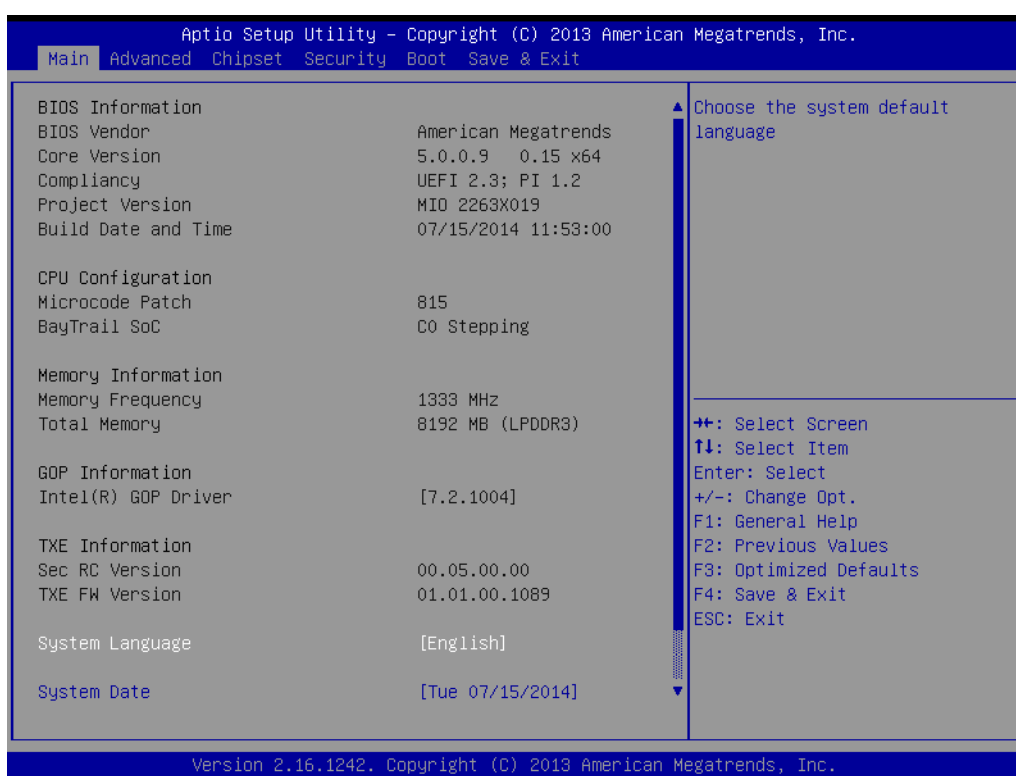

The Main BIOS setup screen has two main frames. The left frame displays all the options that can be configured. Grayed-out options cannot be configured; options in blue can. The right frame displays the key legend.

Above the key legend is an area reserved for a text message. When an option is selected in the left frame, it is highlighted in white. Often a text message will accompany it.

■ System time / System date

Use this option to change the system time and date. Highlight System Time or System Date using the <Arrow> keys. Enter new values through the keyboard. Press the <Tab> key or the <Arrow> keys to move between fields. The date must be entered in MM/DD/YY format. The time must be entered in HH:MM:SS format.

3.2.2 Advanced BIOS Features Setup

Select the Advanced tab from the MIO-2263 setup screen to enter the Advanced BIOS Setup screen. Users can select any item in the left frame of the screen, such as CPU Configuration, to go to the sub menu for that item. Users can display an Advanced BIOS Setup option by highlighting it using the <Arrow> keys. All Advanced BIOS Setup options are described in this section. The Advanced BIOS Setup screens are shown below. The sub menus are described on the following pages.

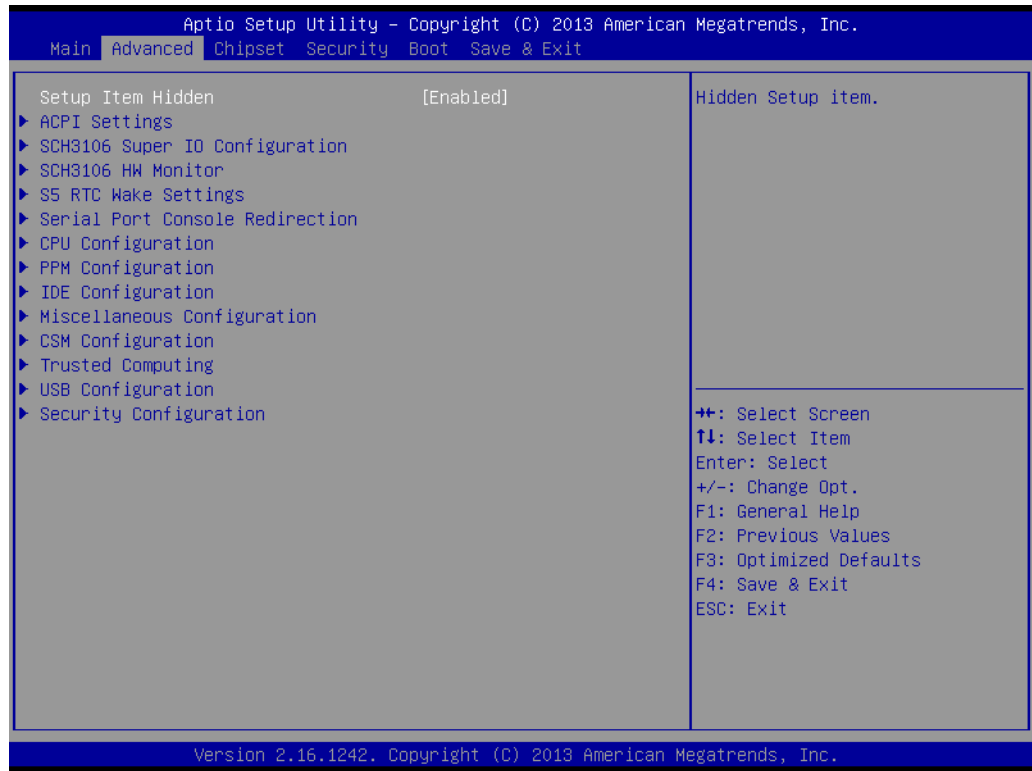

3.2.2.1 ACPI Settings Configuration

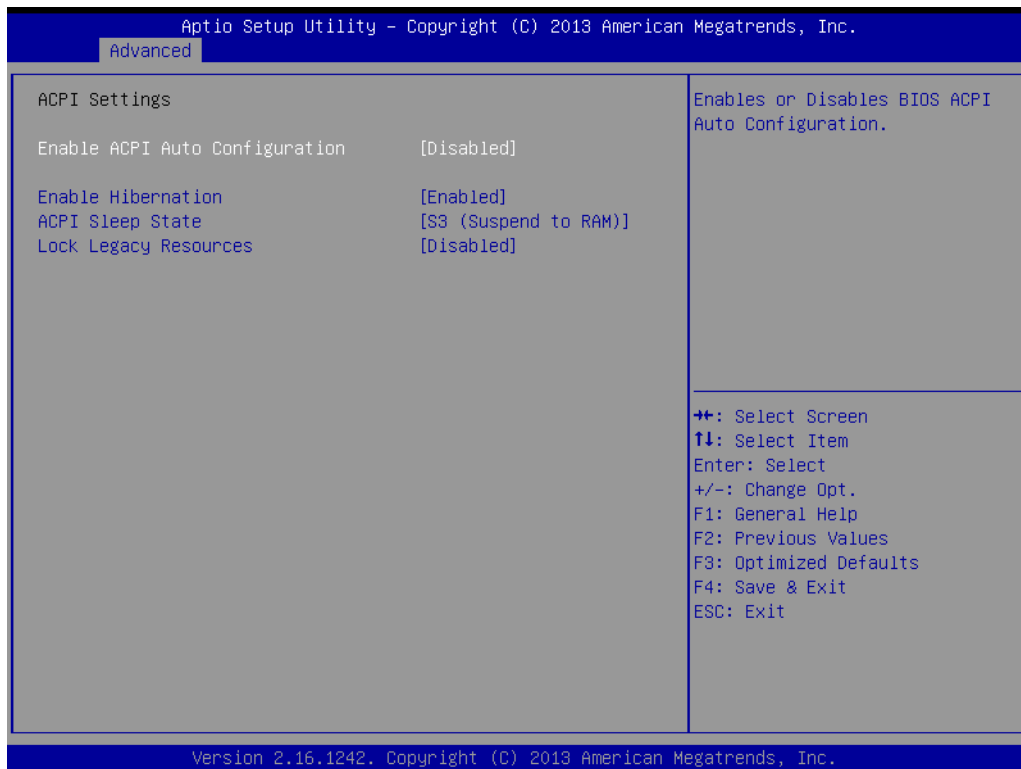

- **Enable ACPI Auto Configuration**
Enable or disable BIOS ACPI auto configuration.
- **Enable Hibernation**
Enables or Disables System ability to Hibernate (OS/S4 Sleep State). This option may be not effective with some OS.
- **ACPI Sleep State**
Select the highest ACPI sleep state the system will enter when the SUSPEND button is pressed.
- **Lock Legacy Resources**
Enables or Disables Lock of Legacy Resources

3.2.2.2 Super I/O Configuration

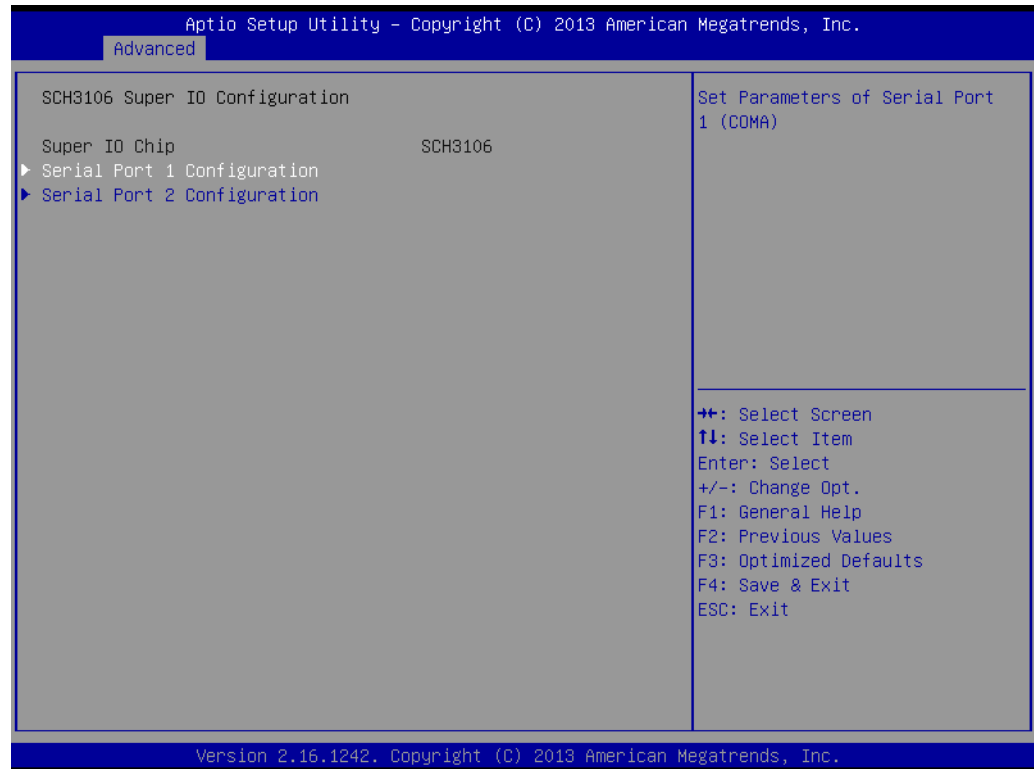

- **Serial Port 1 Configuration**
Set Parameters of Serial Port 1 (COMA)
- **Serial Port 2 Configuration**
Set Parameters of Serial Port 2 (COMB)

3.2.2.3 H/W Monitor

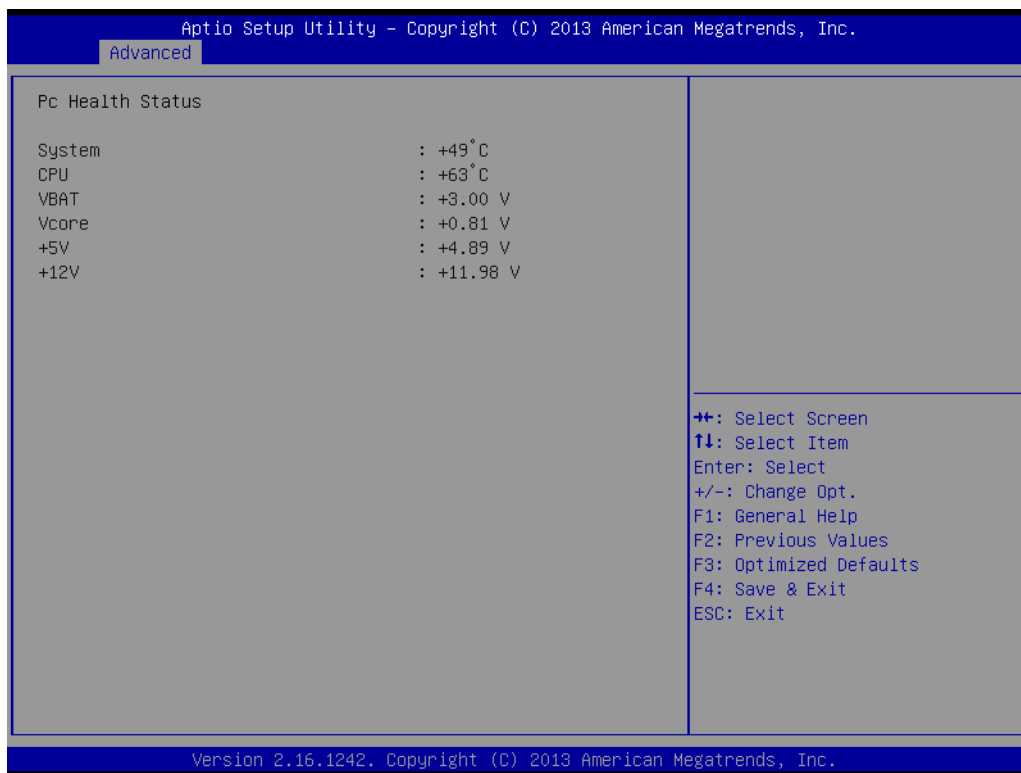

- **Pc Health Status**
This page displays all the information about system Temperature/Voltage.

3.2.2.4 S5 RTC Wake Settings

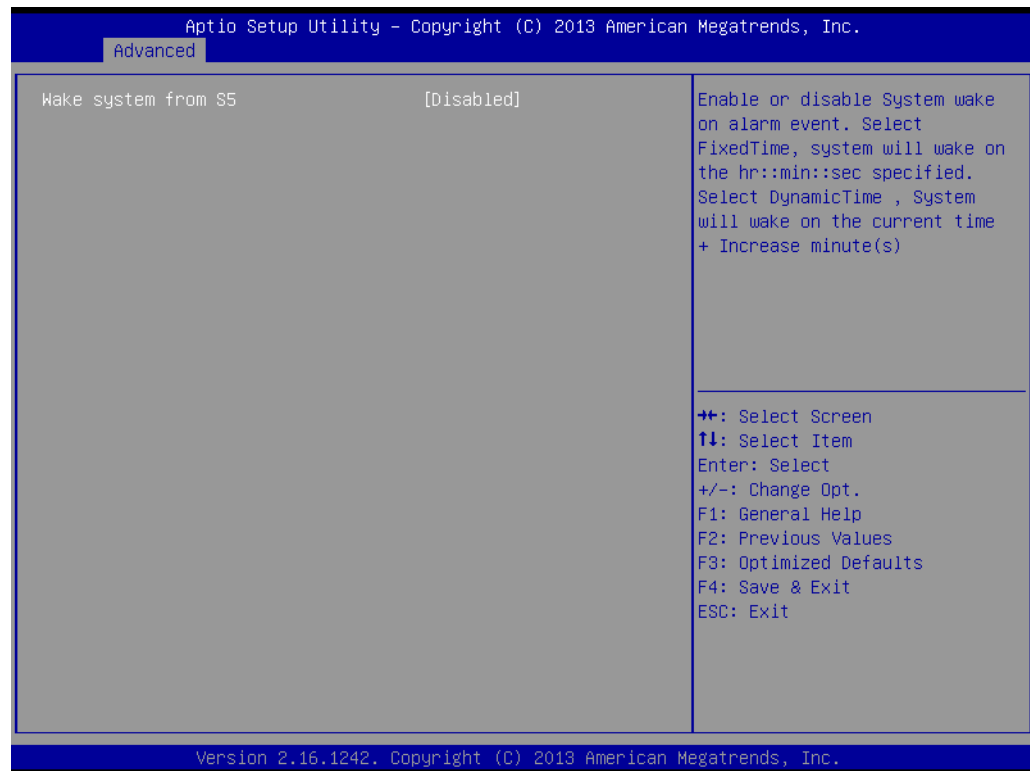

- **Wake system with Fixed Time**
Enable or disable System wake on alarm event. Selecting FixedTime, system will wake on the hr:min:sec specified. Selecting DynamicTime, System will wake on the current time + Increase minute(s).

3.2.2.5 Serial Port Console Redirection

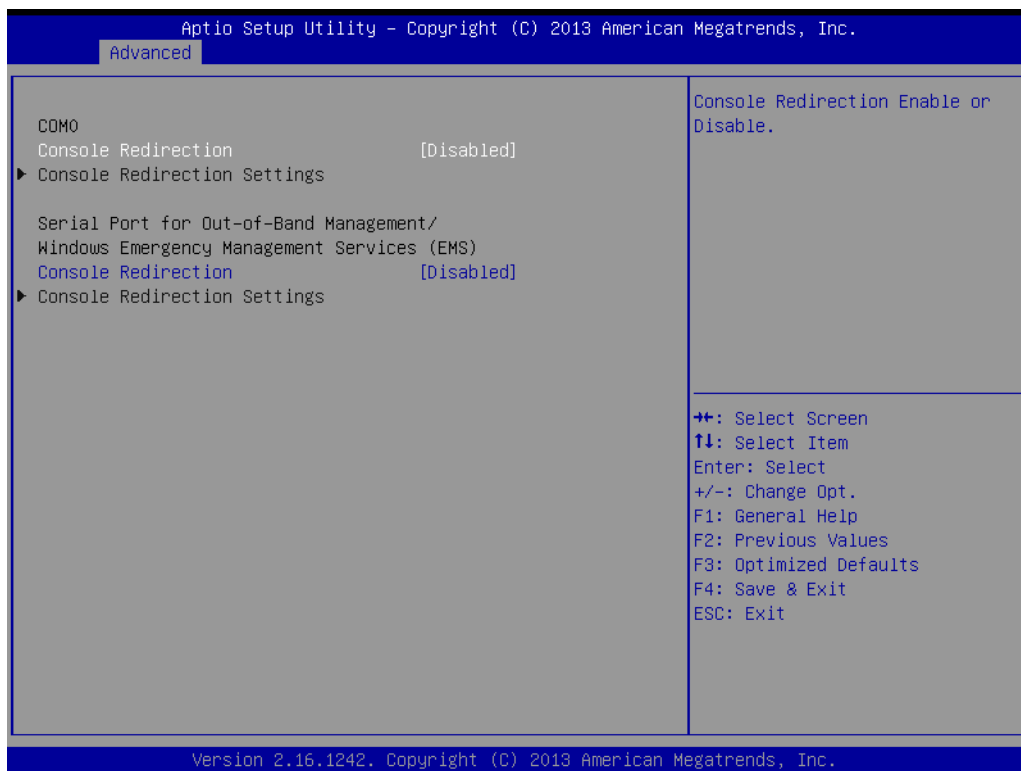

- **Console Redirection**
This item allows users to enable or disable console redirection for Microsoft Windows Emergency Management Services (EMS).
- **Console Redirection**
This item allows users to configure console redirection detail settings.

3.2.2.6 CPU Configuration



- **PPS Support**
This item allows you to enable or disable the ACPI _PPC, _PSS, and _PCT objects.
- **Limit CPUID Maximum**
Disabled for Windows XP
- **Execute Disable Bit**
XD can prevent certain classes of malicious buffer overflow attacks when combined with a supporting OS (Windows Server 2003 SP1, Windows XP SP2, SuSE Linux 9.2, RedHat Enterprise 3 Update 3.)
- **Intel Virtualization Technology**
When enabled, a VMM can utilize the additional hardware capabilities provided by Vanderpool Technology.
- **Power Technology**
Enables power management features.

3.2.2.7 PPM Configuration

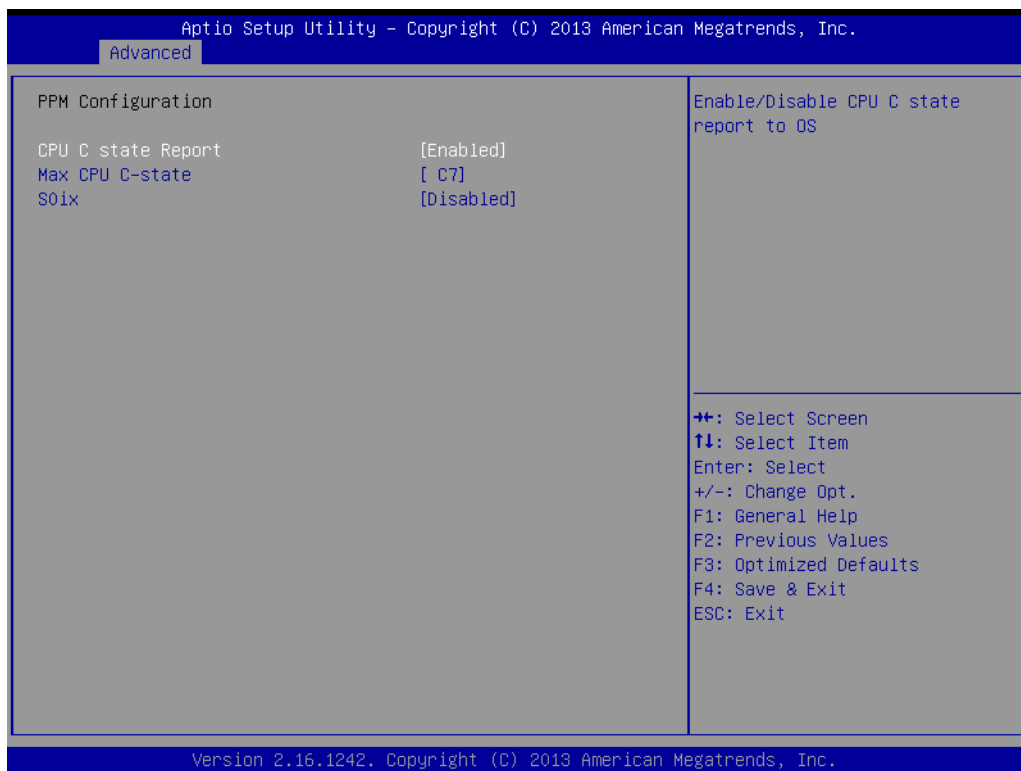

- **CPU C state Report**
Enable/Disable CPU C state report to OS
- **Max CPU C-state**
This option controls Max C states that the processor will support
- **S0ix**
Enable/Disable CPU S0ix state

3.2.2.8 IDE Configuration

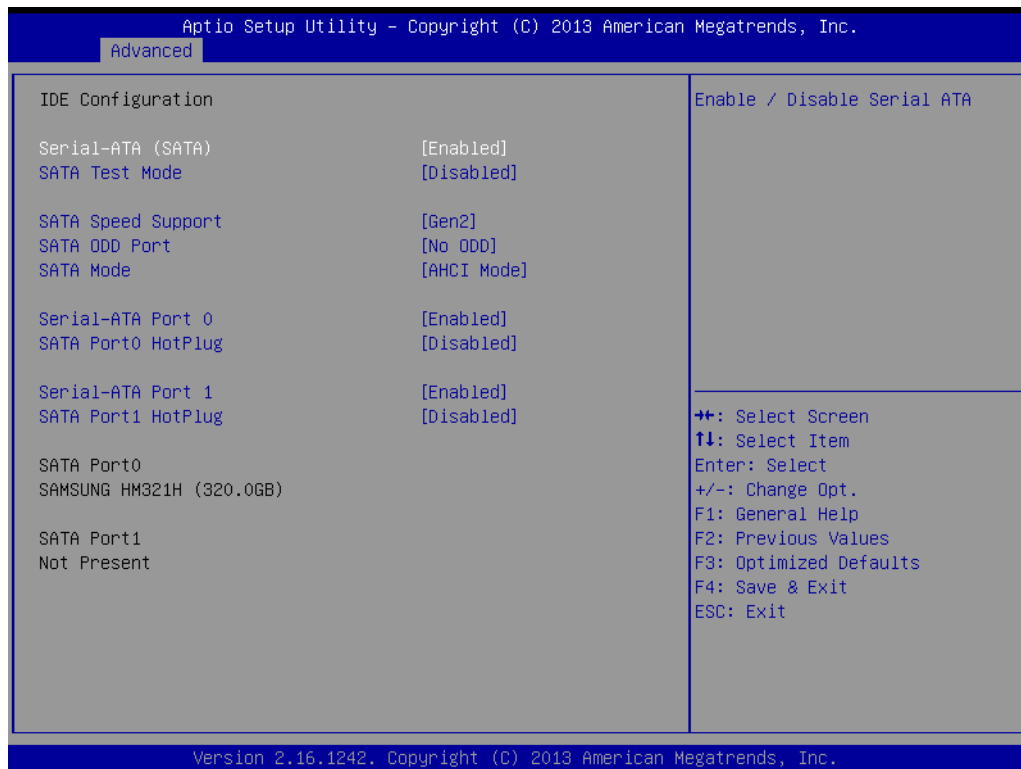

- **Serial-ATA (SATA)**
Enable / Disable Serial ATA
- **SATA Test Mode**
Test Mode Enable / Disable.
- **SATA Speed Support**
SATA Speed Supports Gen1 or Gen2
- **SATA ODD Port**
SATA ODD is Port0 or Port1
- **SATA Mode**
Select IDE / AHCI
- **Serial-ATA Port 0**
Enable / Disable Serial ATA Port 0

3.2.2.9 Miscellaneous Configuration



- **OS Selection**
OS Selection to choose Windows 8.X / Windows 7

3.2.2.10 CSM Configuration

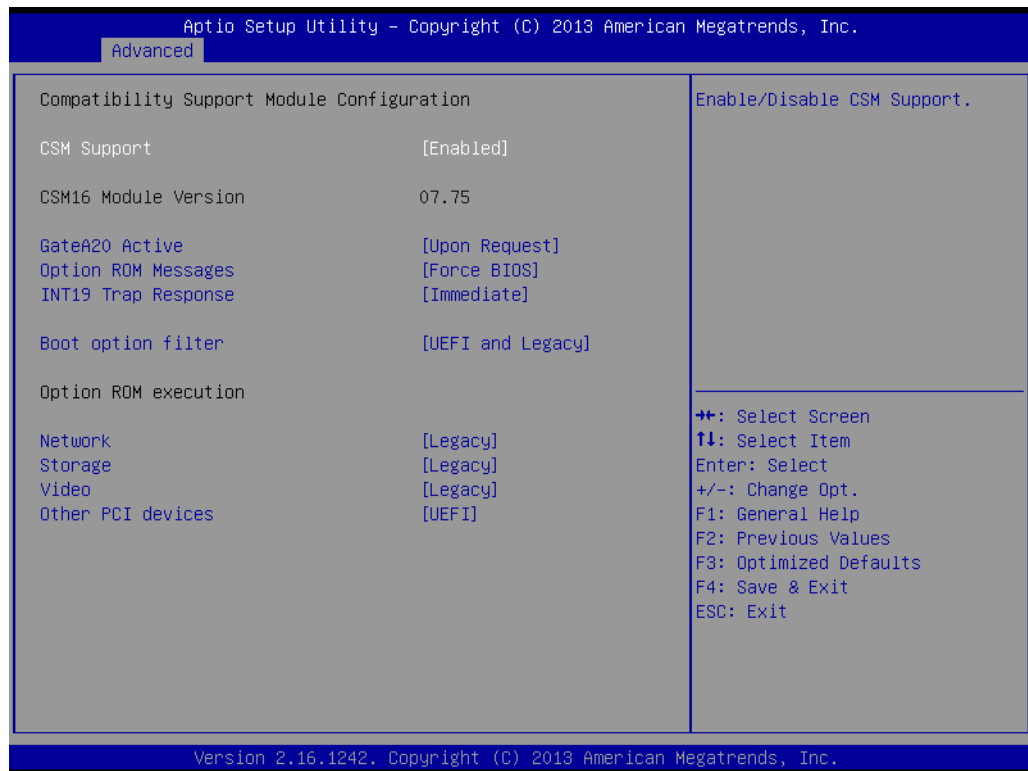

- **CSM Support**
Enable/Disable CSM Support.
- **GateA20 Active**
UPON REQUEST - GA20 can be disabled using BIOS services. ALWAYS - do not allow disabling GA20; this option is useful when any RT code is executed above 1 MB.
- **Option ROM Messages**
Set display mode for Option ROM
- **INT19 Trap Response**
BIOS reaction on INT19 trapping by Option ROM: IMMEDIATE - execute the trap right away; POSTPONED - execute the trap during legacy boot.
- **Boot option filter**
This option controls Legacy/UEFI ROMs priority
- **Network**
Controls the execution of UEFI and Legacy PXE OpROM
- **Storage**
Controls the execution of UEFI and Legacy Storage OpROM
- **Video**
Controls the execution of UEFI and Legacy Video OpROM
- **Other PCI devices**
Determines OpROM execution policy for devices other than Network, Storage, or Video

3.2.2.11 Trusted Computing



- TPM support**
 Enables or Disables BIOS support for security device. OS will not show Security Device. TCG EFI protocol and INT1A interface will not be available.

MIO-2263 doesn't include TPM device. If the client require TPM function of MIO-2263, please contact with Advantech.Co. directly for more details.

3.2.2.12 USB Configuration



- **Legacy USB Support**
Enables support for legacy USB. Auto option disables legacy support if no USB devices are connected. DISABLE option will keep USB devices available only for EFI applications.
- **XHCI Hand-Off**
This is a workaround for OS without XHCI hand-off support. The XHCI ownership change should be claimed by the XHCI driver.
- **EHCI Hand-Off**
This is a workaround for OS without EHCI hand-off support. The EHCI ownership change should be claimed by EHCI driver.
- **USB Mass Storage Driver Support**
This item allows you to enable or disable the USB mass storage device support.
- **Device reset time-out**
USB mass storage device start unit command time-out.
- **Device power-up delay**
Maximum time the device will take before it properly report itself to the host controller. "Auto" uses default value: for a Root port it is 100 ms, for a hub port the delay is taken from hub descriptor.

3.2.2.13 Security Configuration

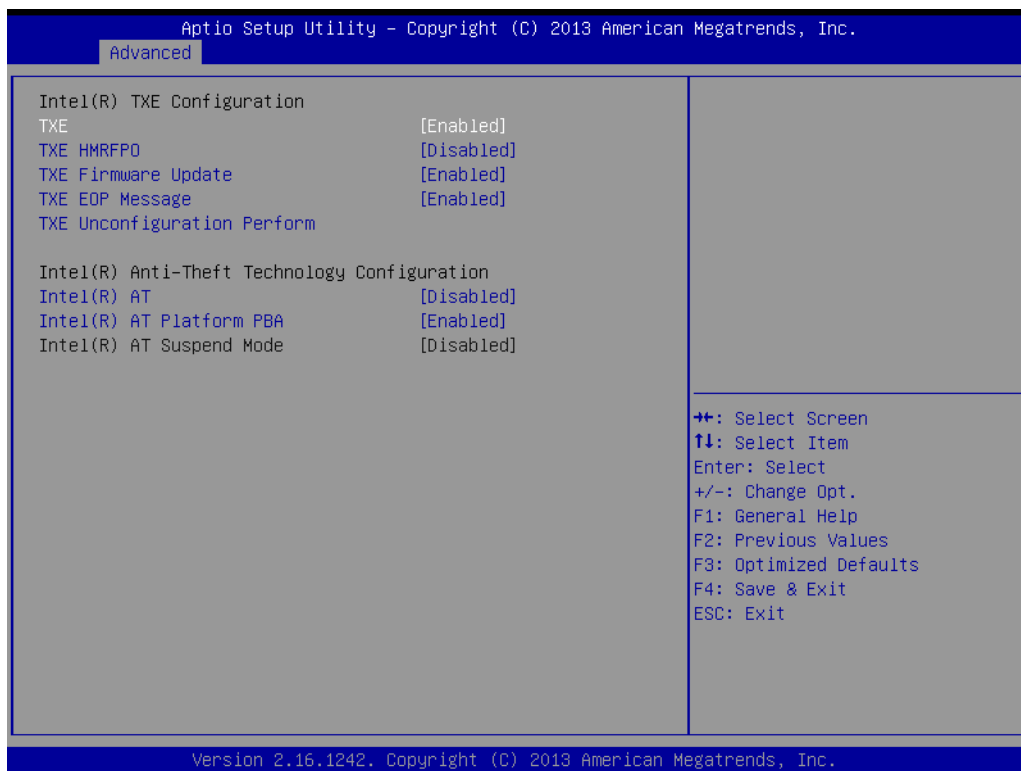

- **SMART Self Test**
This item allows you to enable or disable the SMART self test function.
- **TXE**
- **TXE HMRFPD Disable**
- **TXE Firmware Update**
- **TXE EOP Message**
Send EOP Message before entering the OS.
- **TXE Unconfiguration Perform**
Revert TXE settings to factory defaults.
- **Intel(R) AT**
Enable/Disable BIOS AT code from running.
- **Intel(R) AT Platform PBA**
Enable/Disable BIOS AT code from running.

3.2.3 Chipset Configuration

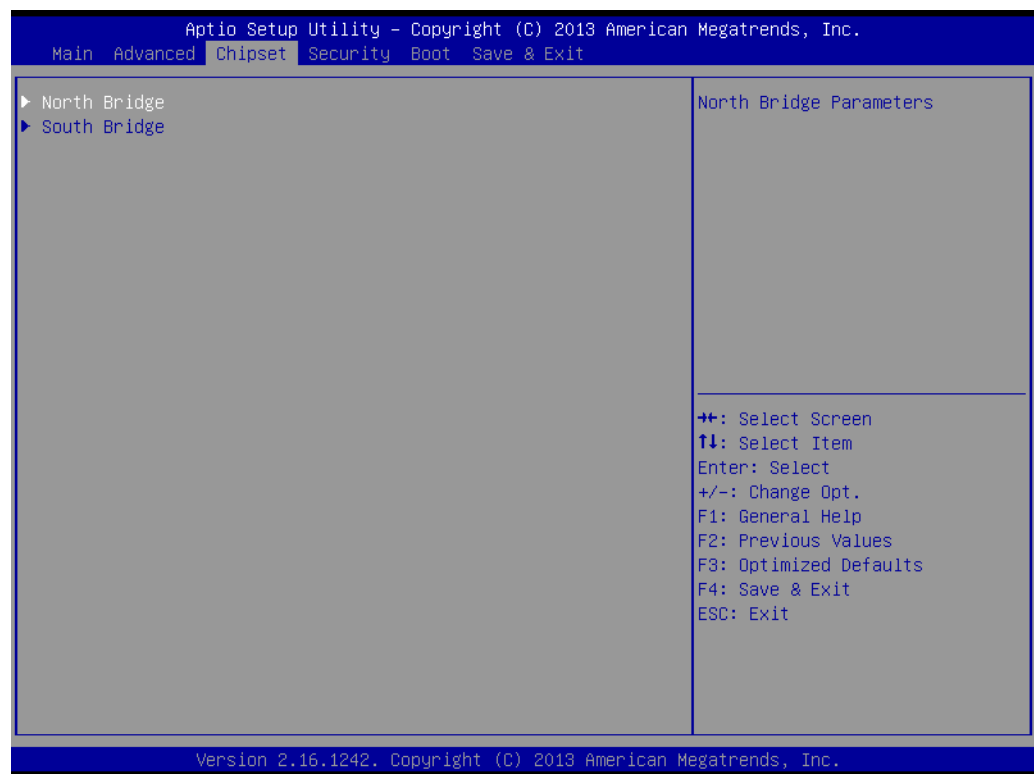

- **North Bridge**
Details for North Bridge items.
- **LVDS Config Select**
Detail for display items.

3.2.3.1 North Bridge

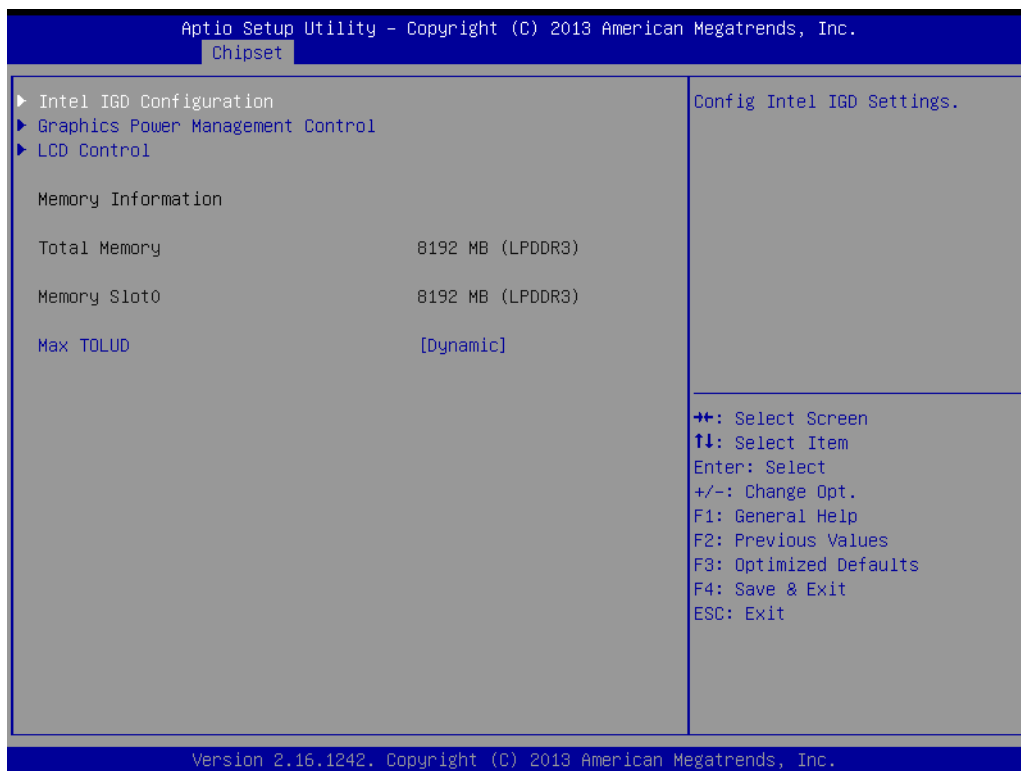

- **Intel IGD Configuration**
Config Intel IGD settings.
- **Graphics Power Management Control**
Graphics Power Management Control options
- **LCD Control**
LCD Control
- **Max TOLUD**
Maximum value of TOLUD

3.2.3.2 Intel IGD Configuration

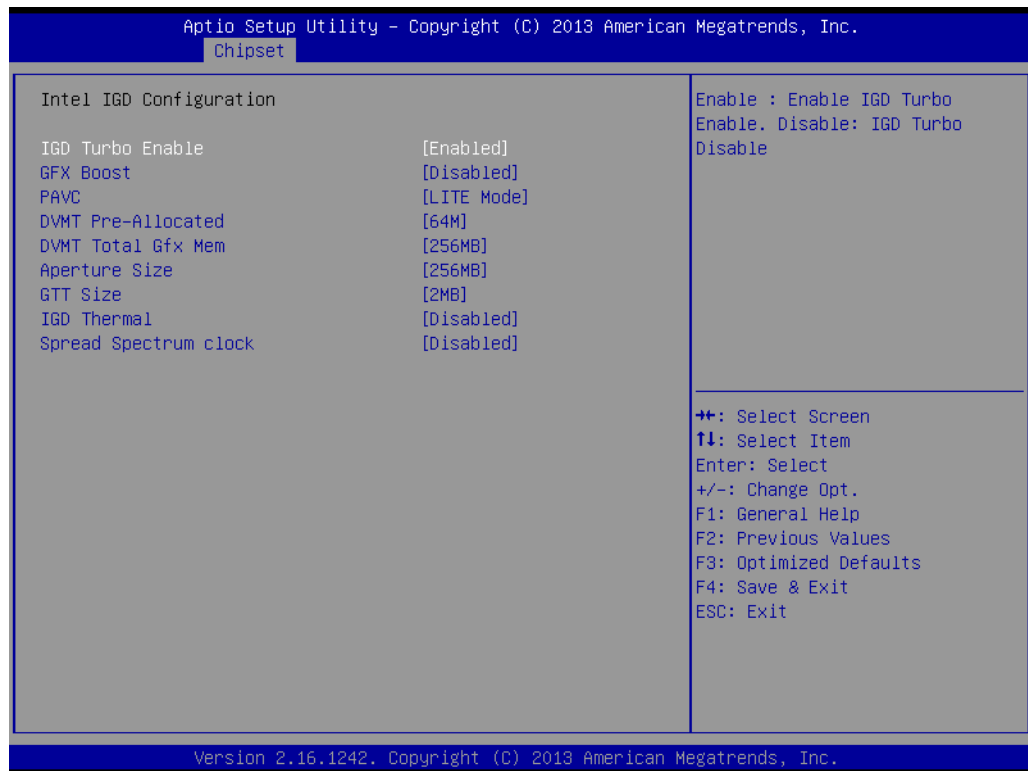

- **Intel IGD Configuration**
Config Intel IGD settings.
- **IGD Turbo Enable**
Enable: Enable IGD Turbo Enable. Disable: IGD Turbo Disable
- **GFX Boost**
Enable/Disable GFX boost
- **PAVC**
Enable/Disable protected audio video control
- **DVMT Pre-Allocated**
Select DVMT 5.0 Pre-Allocated (Fixed) graphics memory size used by the Internal graphics device.
- **DVMT Total Gfx Mem**
Select DVMT 5.0 total graphic memory size used by the internal graphics device.
- **Aperture Size**
Select the aperture size
- **GTT Size**
Select the GTT size
- **IGD Thermal**
Enable/Disable IGD thermal
- **Spread Spectrum clock**
Enable/Disable spread spectrum clock

3.2.3.3 Graphics Power Management Control

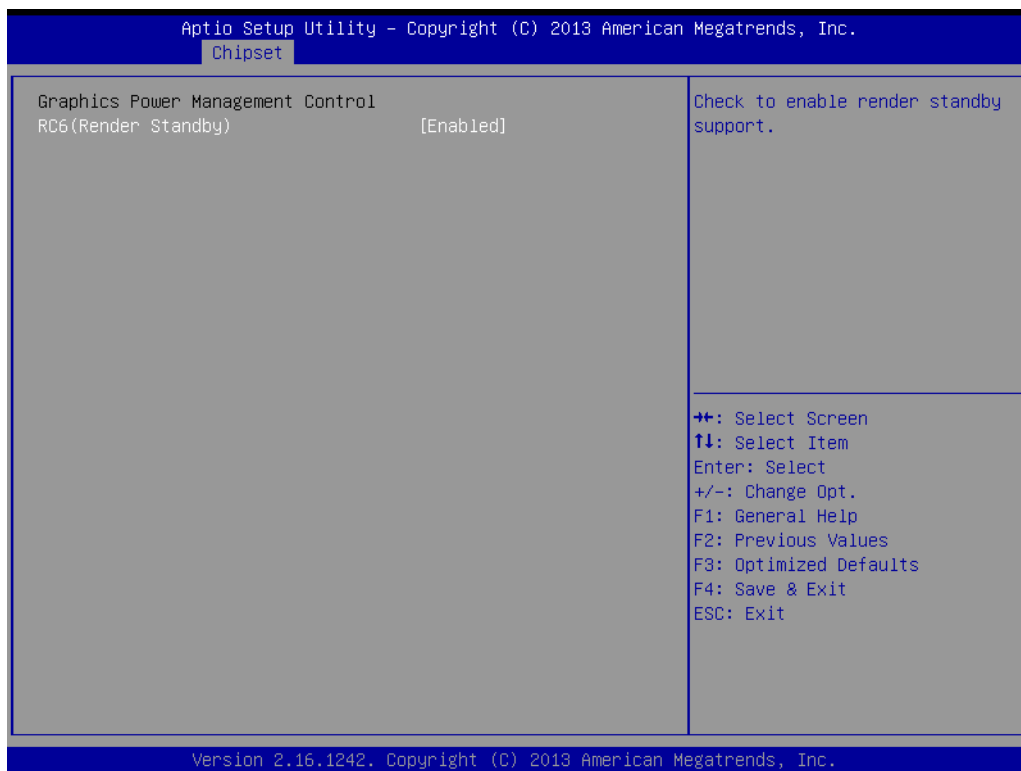

- **RC6 (Render Standby)**
Check to enable render standby support.

3.2.3.4 LCD Control

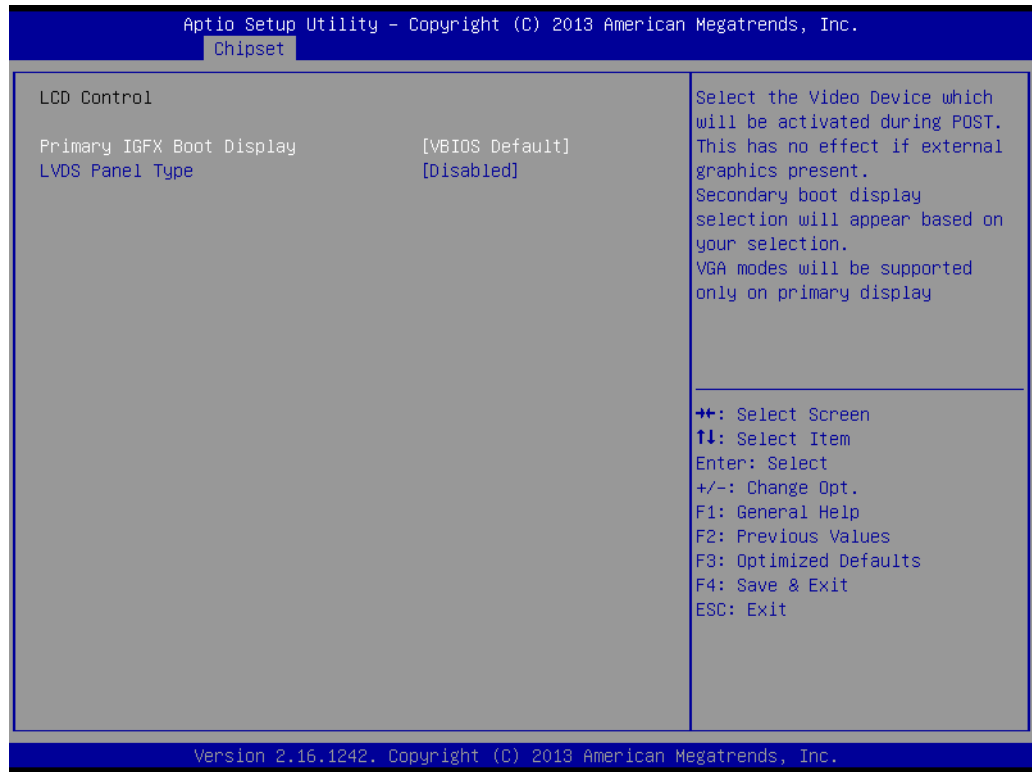

- **Primary IGFX Boot Display**
Select the video device which will be activated during POST. This has no effect if external graphics are present. Secondary boot display selection will appear based on your selection. VGA modes will be supported only on the primary display.
- **LVDS Panel Type**

3.2.3.5 South Bridge

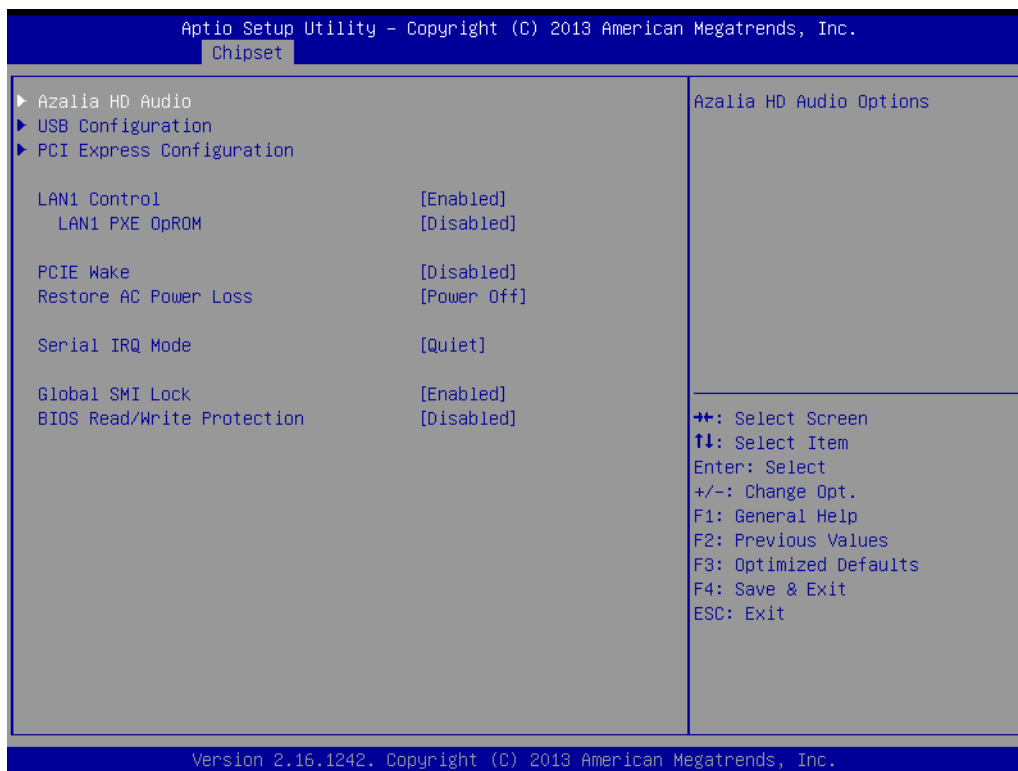

- **SB SATA Configuration**
Options for SATA configuration.
- **SB USB Configuration**
Options for SB USB configuration.
- **SB HD Azalia Configuration**
Options for SB HD Azalia.
- **PCI-E Port**
Options for PCI-E devices control.
- **Restore on AC Power Loss**
This item allows you to select system restore states if AC power loss.
- **Azalia HD Audio**
Azalia HD audio options
- **USB Configuration**
USB configuration settings
- **PCI Express Configuration**
PCI Express configuration settings
- **LAN1 Control**
Enable or Disable the LAN1.
- **LAN1 PXE OpROM**
Enable or Disable boot option for LAN1 controller.
- **PCIE Wake**
Enable or Disable PCIE to wake the system from S5.
- **Restore AC Power Loss**
Select AC power state when the power is re-applied after a power failure.
- **Serial IRQ Mode**

Configure Serial IRQ Mode.

- **Global SMI Lock**
Enable or Disable SMI lock.
- **BIOS Read/Write Protection**
Enable or Disable BIOS SPI region read/write protect.

3.2.3.6 Azalia HD Audio

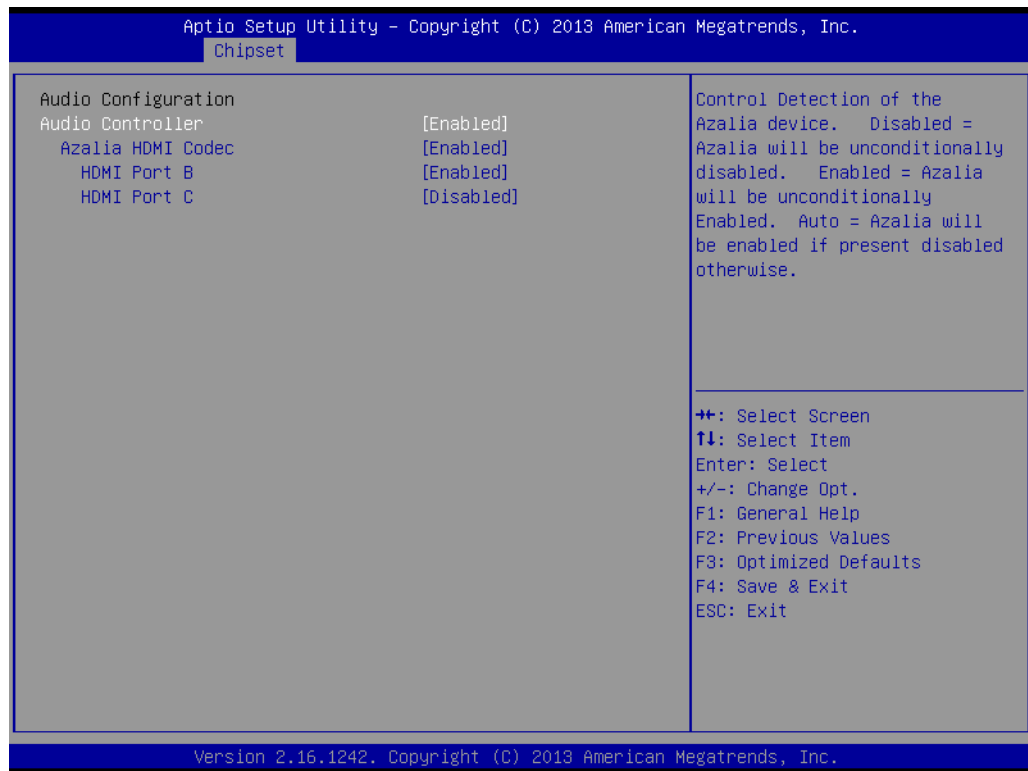

- **Audio Controller**
Control Detection of the Azalia device. Disabled = Azalia will be unconditionally disabled. Enabled = Azalia will be unconditionally Enabled. Auto = Azalia will be enabled if present disabled otherwise.
- **Azalia HDMI Codec**
Enable/Disable internal HDMI codec for Azalia
- **HDMI Port B**
Enable/Disable HDMI Port B
- **HDMI Port C**
Enable/Disable HDMI Port C

3.2.3.7 USB Configuration

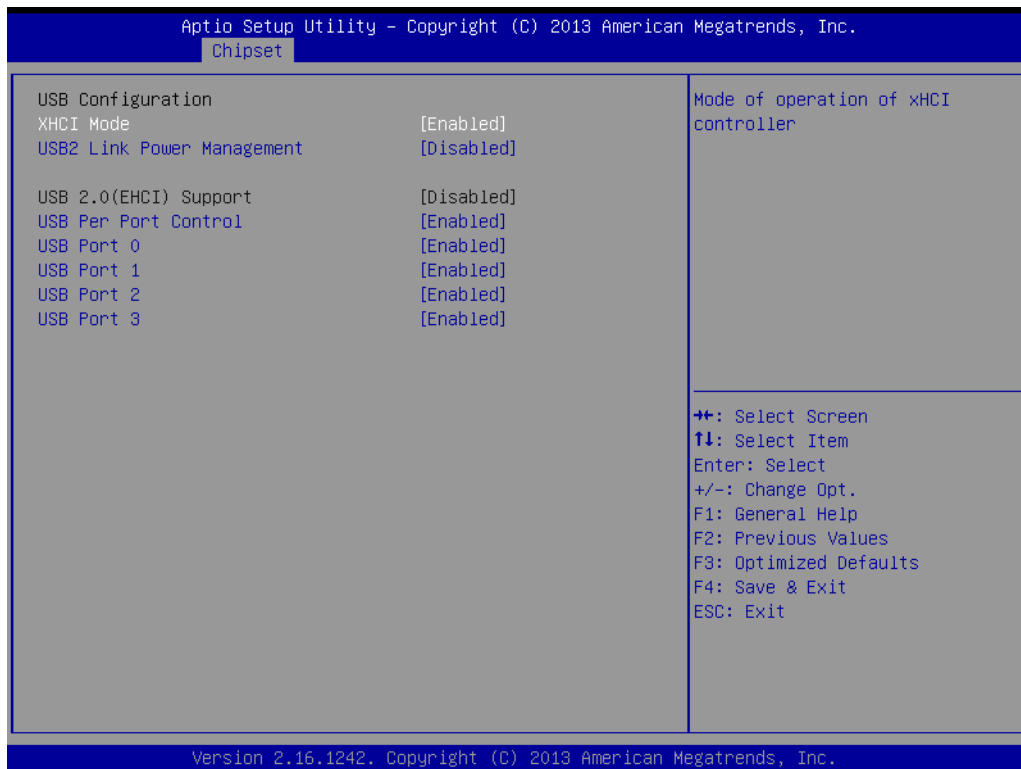

- **XHCI Mode**
Mode of operation of xHCI controller.
- **USB2 Link Power Management**
Enable/Disable USB2 Link Power Management.
- **USB 2.0(EHCI) Support**
Control the USB EHCI (USB 2.0) functions. One EHCI controller must always be enabled.
- **USB Per Port Control**
Control each of the USB ports (0~3). Enable: Enable USB per port; Disable: Use USB port X settings.

3.2.3.8 PCI Express Configuration

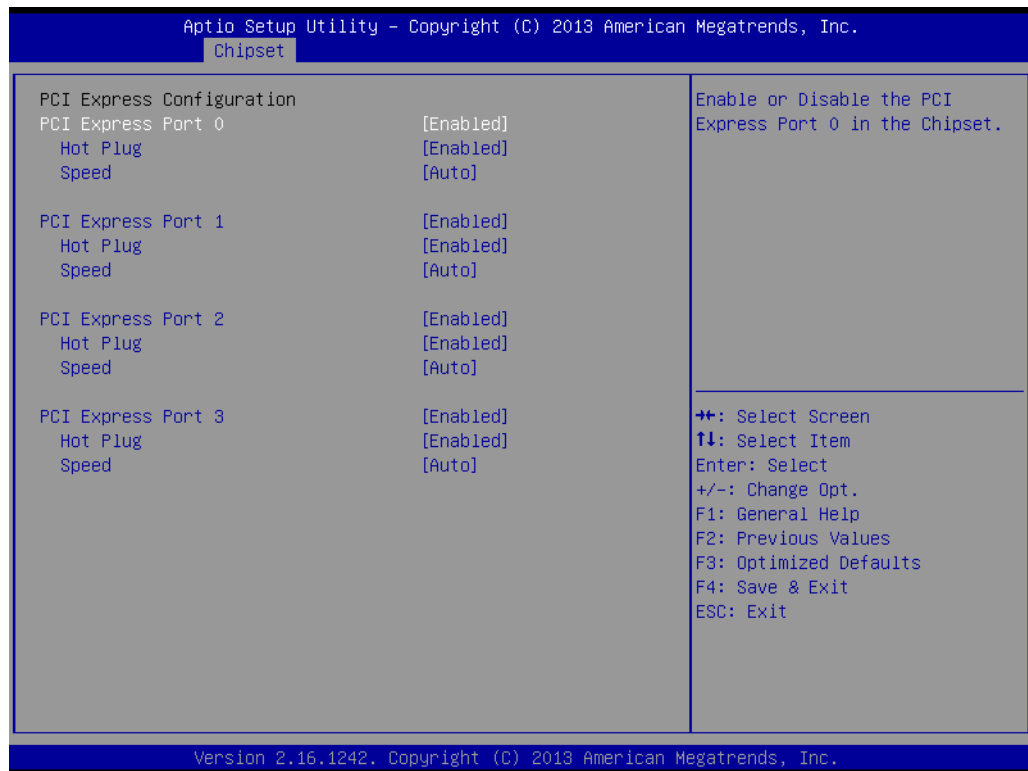

- **PCI Express Port 0**
Enable or Disable the PCI Express Port 0 in the chipset.
- **Hot Plug**
Enable or disable PCI Express Hot Plug.
- **Speed**
Configure PCIe port speed

3.2.4 Security

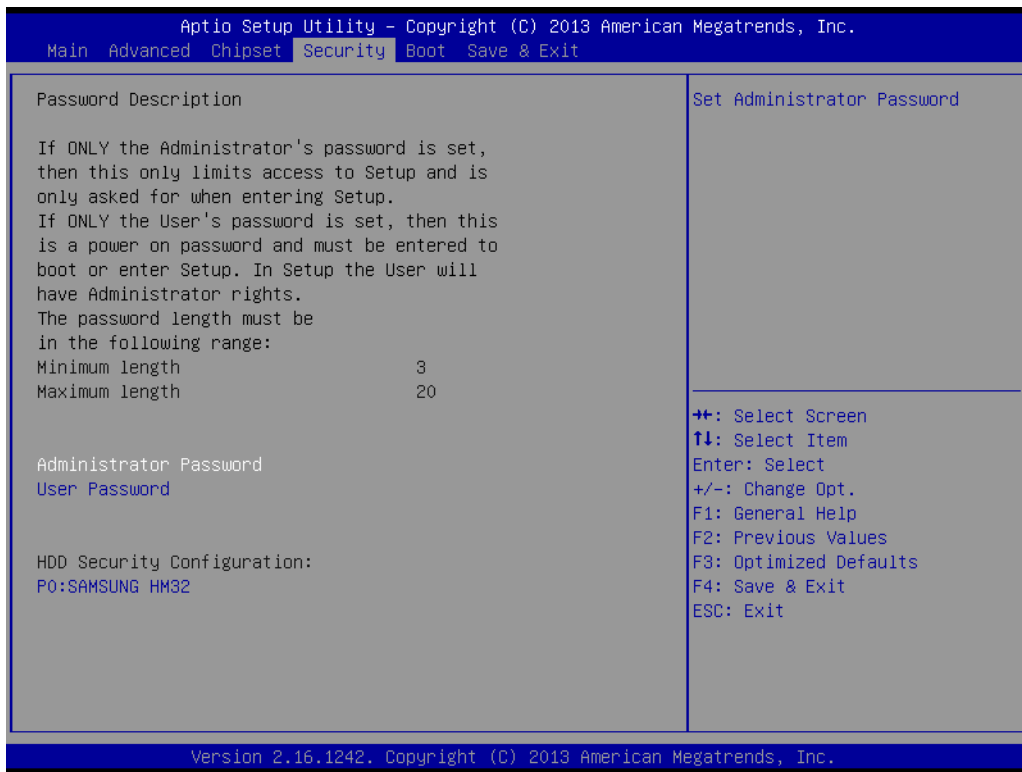

Select Security Setup from the MIO-2263 Setup main BIOS setup menu. All Security Setup options, such as password protection and virus protection are described in this section. To access the sub menu for the following items, select the item and press <Enter>:

- **Change Administrator / User Password**

3.2.5 Boot

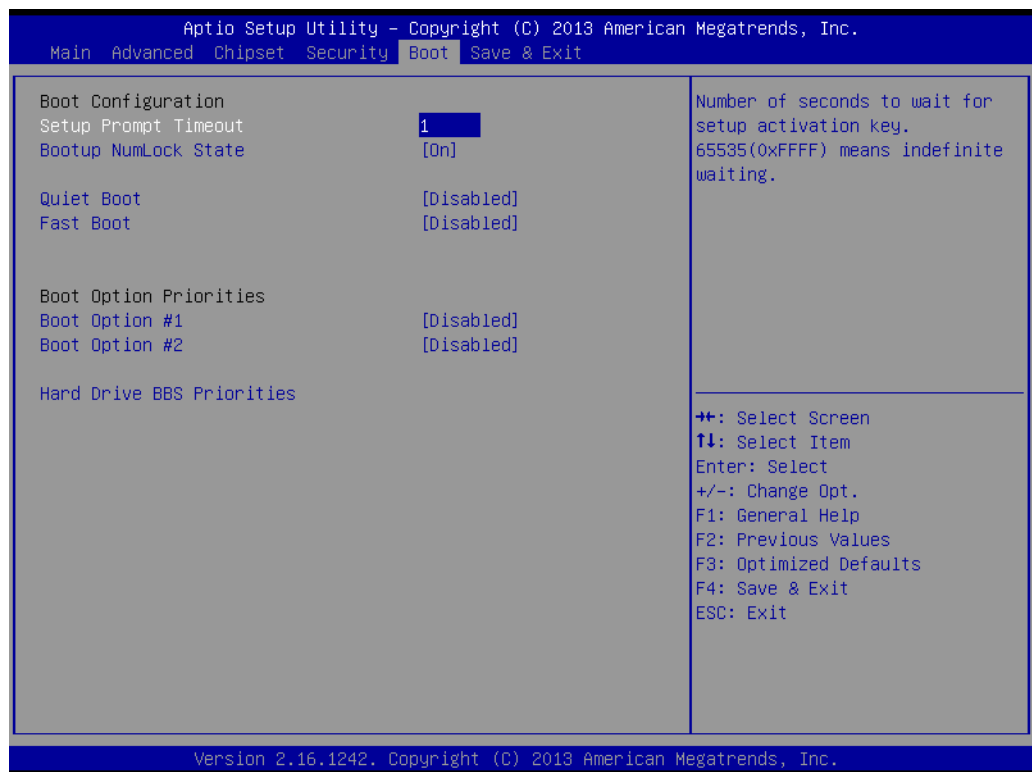

- **Setup Prompt Timeout**
Number of seconds that the firmware will wait before initiating the original default boot selection. A value of 0 indicates that the default boot selection is to be initiated immediately on boot. A value of 65535(0xFFFF) indicates that firmware will wait for user input before booting. This means the default boot selection is not automatically started by the firmware.
- **Bootup NumLock State**
Select the keyboard NumLock state.
- **Quiet Boot**
Enables or disables the Quiet Boot option.
- **Fast Boot**
Enables or disables boot with initialization of a minimal set of devices required to launch active boot option. Has no effect for BBS boot options.
- **Boot Option #1**
Sets the system boot order.

3.2.6 Save & Exit



- **Save Changes and Exit**
This item allows you to exit system setup after saving the changes.
- **Discard Changes and Exit**
This item allows you to exit system setup without saving any changes.
- **Save Changes and Reset**
This item allows you to reset the system after saving the changes.
- **Discard Changes and Reset**
This item allows you to rest system setup without saving any changes.
- **Save Changes**
This item allows you to save changes done so far to any of the options.
- **Discard Changes**
This item allows you to discard changes done so far to any of the options.
- **Restore Defaults**
This item allows you to restore/load default values for all the options.
- **Save as User Defaults**
This item allows you to save the changes done so far as user defaults.
- **Restore User Defaults**
This item allows you to restore the user defaults to all the options.
- **Boot Override**
Boot device select can override your boot priority.

Chapter 4

S/W Introduction &
Installation

4.1 S/W Introduction

The mission of Advantech Embedded Software Services is to "Enhance quality of life with Advantech platforms and Microsoft® Windows® embedded technology." We enable Windows embedded software products on Advantech platforms to more effectively support the embedded computing community. Customers are freed from the hassle of dealing with multiple vendors (Hardware suppliers, System integrators, Embedded OS distributor) for projects. Our goal is to make Windows embedded software solutions easily and widely available to the embedded computing community.

4.2 Driver Installation

4.2.1 Windows 7 Professional

To install the drivers, insert the driver CD into DVD-ROM, select the drivers that need to be installed, then launch setup file under each function folder and follow Driver Setup instructions to complete the process.

4.2.2 Other OS

To install the drivers for another Windows OS or Linux, please browse the CD to run the setup file under the appropriate OS folder (s).

4.3 Value-Added Software Services

Software API: An interface that defines the ways by which an application program may request services from libraries and/or operating systems. Provides not only the underlying drivers required but also a rich set of user-friendly, intelligent and integrated interfaces, which speeds development, enhances security and offers add-on value for Advantech platforms.

4.3.1 SUSI Introduction

To make hardware easier and more convenient to access for programmers, Advantech has released a suite of API (Application Programming Interface) in the form of a program library. The program Library is called Secured and Unified Smart Interface or SUSI for short.

In modern operating systems, user space applications cannot access hardware directly. Drivers are required to access hardware. User space applications access hardware through drivers. Different operating systems usually define different interface for drivers. This means that user space applications call different functions for hardware access in different operating systems. To provide a uniform interface for accessing hardware, an abstraction layer is built on top of the drivers and SUSI is such an abstraction layer. SUSI provides a uniform API for application programmers to access the hardware functions in different Operating Systems and on different Advantech hardware platforms.

Application programmers can invoke the functions exported by SUSI instead of calling the drivers directly. The benefit of using SUSI is portability. The same set of APIs is defined for different Advantech hardware platforms. Also, the same API set is implemented in different Operating Systems. This user's manual describes some sample programs and the API in SUSI. The hardware functions currently supported by SUSI can be grouped into a few categories including Watchdog, I²C, SMBus, GPIO, and VGA control. Each category of API in SUSI is briefly described below.

4.3.2 Software APIs

4.3.2.1 The GPIO API

General Purpose Input/Output is a flexible parallel interface that allows a variety of custom connections. It allows users to monitor the level of signal input or set the output status to switch on/off a device. Our API also provides Programmable GPIO, which allows developers to dynamically set the GPIO input or output status.

4.3.2.2 The SMBus API

The System Management Bus (SMBus) is a two-wire interface defined by Intel Corporation in 1995. It is based on the same principles of operation of I²C and is used in personal computers and servers for low-speed system management communications. Nowadays, it can be seen in many types of embedded systems. As with other API in SUSI, the SMBus API is available on many platforms including Windows 7.

4.3.2.3 The Display Control API

There are two kinds of VGA control APIs, backlight on/off control and brightness control. Backlight on/off control allows a developer to turn on or off the backlight, and to control brightness smoothly.

1. Brightness Control
 - The Brightness Control API allows a developer to interface with an embedded device to easily control brightness.
2. Backlight Control
 - The Backlight API allows a developer to control the backlight (screen) on/off in an embedded device.

4.3.2.4 The Watchdog API

A watchdog timer (abbreviated as WDT) is a hardware device which triggers an action, e.g. rebooting the system, if the system does not reset the timer within a specific period of time. The WDT API in SUSI provides developers with functions such as starting the timer, resetting the timer, and setting the timeout value if the hardware requires customized timeout values.

4.3.2.5 The Hardware Monitor API

The hardware monitor (abbreviated as HWM) is a system health supervision capability achieved by placing certain I/O chips along with sensors for inspecting the target of interests for certain condition indexes, such as fan speed, temperature and voltage etc.

However, due to the inaccuracy among many commercially available hardware monitoring chips, Advantech has developed a unique scheme for hardware monitoring - achieved by using a dedicated micro-processor with algorithms specifically designed for providing accurate, real-time and reliable data content; helping protect your system in a more reliable manner.

4.3.2.6 The Power Saving API

1. CPU Speed
 - Make use of Intel SpeedStep technology to reduce power consumption. The system will automatically adjust the CPU Speed depending on system loading.
2. System Throttling
 - Refers to a series of methods for reducing power consumption in computers by lowering the clock frequency. APIs allow the user to lower the clock from 87.5% to 12.5%.

4.3.3 SUSI Installation

SUSI supports many different operating systems. Each subsection below describes how to install SUSI and related software on a specific operating system. Please refer to the subsection matching your operating system.

4.3.3.1 Windows 7

In Windows 7, you can install the library, drivers and demo programs onto the platform easily using the installation tool--The SUSI Library Installer. After the installer has executed, the SUSI Library and related files for Windows 7 can be found in the target installation directory. The files are listed in the following table.

Directory	Contents
\Library	<ul style="list-style-type: none">■ Susi.lib Library for developing the applications on Windows 7.■ Susi.dll Dynamic library for SUSI on Windows 7.
\Demo	<ul style="list-style-type: none">■ SusiDemo.EXE Demo program on Windows® 7.■ Susi.dll Dynamic library for SUSI on Windows 7.
\Demo\SRC	Source code of the demo program on Windows 7.

The following section illustrates the installation process.

Note! *The SUSI Library Installer screen shots shown below are examples only. Your screens may vary depending on your particular version.*



1. Extract Susi.zip.
2. Double-click the "Setup.exe" file.

The installer searches for a previous installation of the SUSI Library. If it locates one, a dialog box opens asking whether you want to modify, repair or remove the software. If a previous version is located, please see the [Maintenance Setup] section. If it is not located, an alternative window appears. Click Next.

4.3.4 SUSI Sample Programs

Sample Programs

The sample programs demonstrate how to incorporate SUSI into your program. The sample programs run in graphics mode in Windows® 7 are described in the subsections below.

Windows Graphics Mode

Each demo application contains an executable file SusiDemo.exe, a shared library Susi.dll and source code within the release package.

SusiDemo.exe is an executable file and it requires the shared library, Susi.dll, to demonstrate the SUSI functions. The source code of SusiDemo.exe must be compiled under Microsoft Visual C++ 6.0 on Windows 7. Developers must add the header file Susi.h and library Susi.lib to their own projects when they want to develop something with SUSI.

SusiDemo.exe

The SusiDemo.exe test application is an application which uses all functions of the SUSI Library. It has five major function blocks: Watchdog, GPIO, SMBus, I²C and VGA control. The following screen shot appears when you execute SusiDemo.exe. You can click function tabs to select test functions respectively. Some function tabs will not show on the test application if your platform does not support such functions. For a complete support list, please refer to Appendix A. We describe the steps to test all functions of this application.

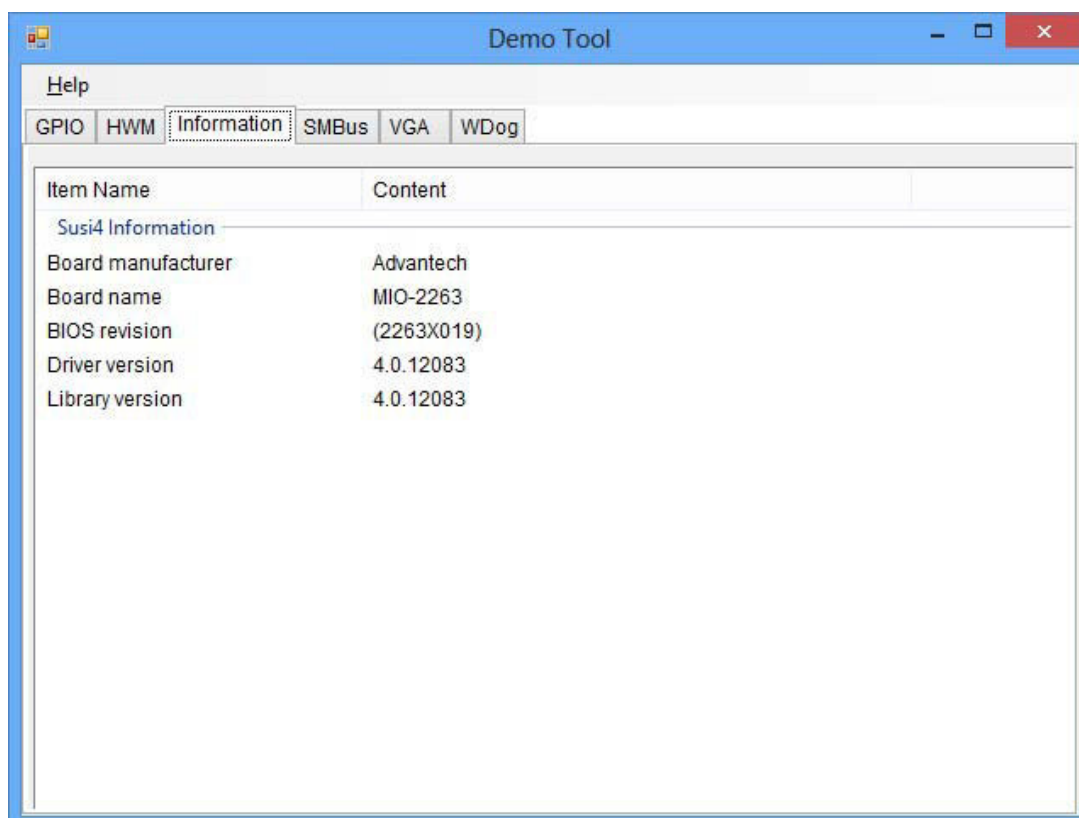

GPIO

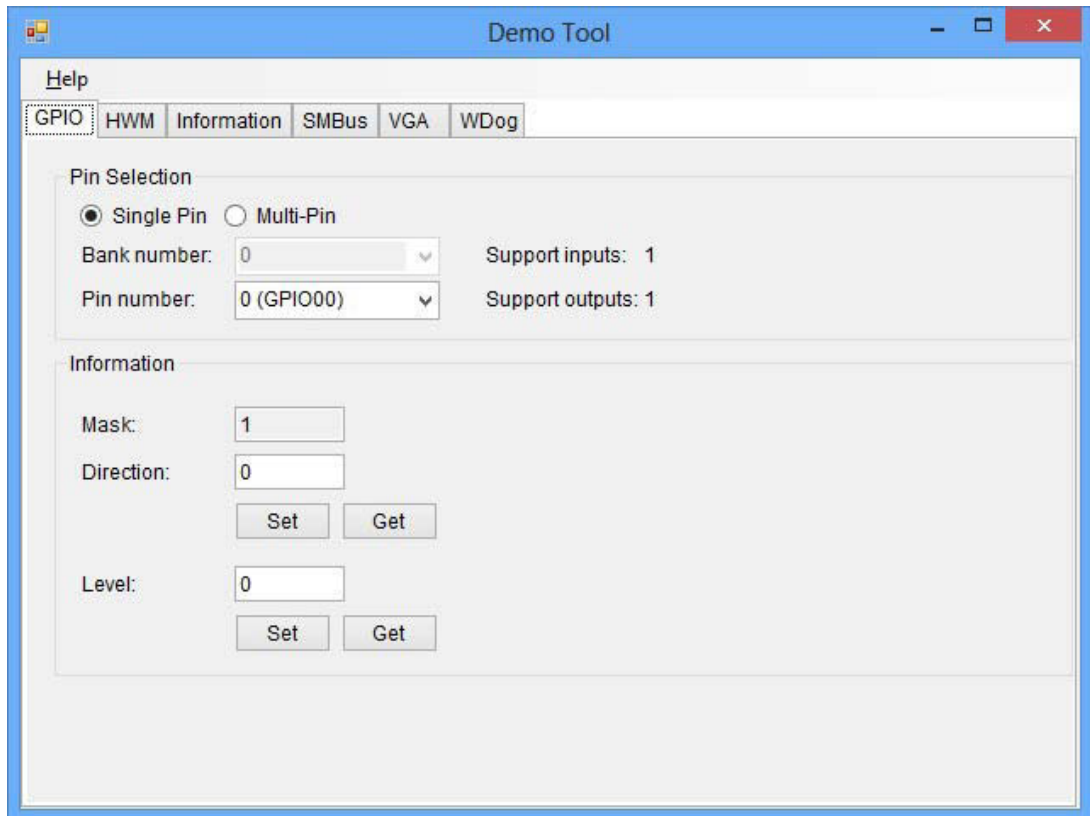

When the application is executed, it will display GPIO information in the GPIO INFORMATION group box. It displays the number of input pins and output pins. You can click the radio button to choose to test either the single pin function or multiple pin functions. The GPIO pin assignments of the supported platforms are located in Appendix B.

- Test Read Single Input Pin
 - Click the radio button- Single-Pin.
 - Key in the pin number to read the value of the input pin. The Pin number starts from '0'.
 - Click the READ GPIO DATA button and the status of the GPIO pin will be displayed in (R/W) Result field.

- Test Read Multiple Input Pin
 - Click the radio button- Multi-Pin.
 - Key in the pin number from '0x01' to '0x0F' to read the value of the input pin. The pin numbers are ordered bitwise, i.e. bit 0 stands for GPIO 0, bit 1 stands for GPIO 1, etc. For example, if you want to read pin 0, 1, and 3, the pin numbers should be '0x0B'.
 - Click READ GPIO DATA button and the statuses of the GPIO pins will be displayed in (R/W) Result field.

- Test Write Single Output Pin
 - Click the radio button- Single-Pin.
 - Key in the pin numbers you want to write. Pin numbers start from '0'.
 - Key in the value either '0' or '1' in (R/W) Result field to write the output pin you chose above step.
 - Click the WRITE GPIO DATA button to write the GPIO output pin.

- Test Write Multiple Output Pins
 - Click the radio button- Multi-Pin.
 - Key in the pin number from '0x01' to '0x0F' to choose the multiple pin numbers to write the value of the output pin. The pin numbers are ordered bitwise, i.e. bit 0 stands for GPIO 0, bit 1 stands for GPIO 1, etc. For example, if you want to write pin 0, 1, and 3, the pin numbers should be '0x0B'.
 - Key in the value in (R/W) Result field from '0x01' to '0x0F' to write the value of the output pin. The pin numbers are ordered bitwise, i.e. bit 0 stands for GPIO 0, bit 1 stands for GPIO 1, etc. For example, if you want to set pin 0 and 1 high, 3 to low, the pin number should be '0x0B', and then you should key in the value '0x0A' to write.
 - Click the WRITE GPIO DATA button to write the GPIO output pins.

SMBus

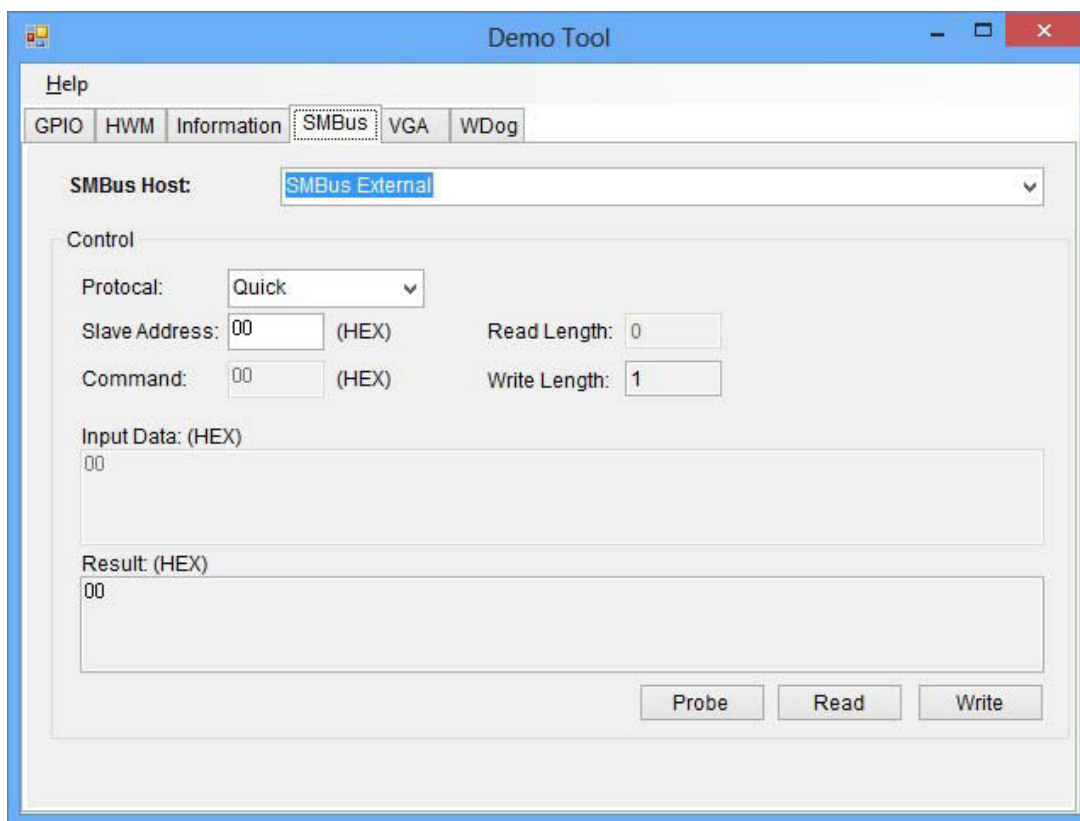

When the application has executed, you can click the radio button to choose to test each access mode, i.e. Access a byte, Access multiple bytes and Access a word. All data must be read or written in hexadecimal except the numbers for radio button: Access multiple bytes mode must be written in decimal. You can test the functionalities of the watchdog as follows:

- Read a byte
 - Click the radio button- Access a byte.
 - Key in the slave device address in the Slave address field.
 - Key in the register offset in the Register Offset field.
 - Click the READ SMBus DATA button and a byte of data from the device will be shown on the Result field.

-
- Write a byte
 - Click the radio button- Access a byte.
 - Key in the slave device address in Slave address field.
 - Key in the register offset in Register Offset field.
 - Key the desired data in the Result field to write to the device.
 - Click the WRITE SMBus DATA button and then the data will be written to the device through SMBus.

 - Read a word
 - Click the radio button- Access a word.
 - Key in the slave device address in the Slave address field.
 - Key in the register offset in the Register Offset field.
 - Click the READ SMBus DATA button and then a word of data from the device will be shown on the Result field.

 - Write a word
 - Click the radio button- Access a word.
 - Key in the slave device address in the Slave address field.
 - Key in the register offset in the Register Offset field.
 - Key in the desired data, such as 0x1234, in the Result field to write to the device.
 - Click the WRITE SMBus DATA button and the data will be written to the device through the SMBus.

 - Read Multiple bytes
 - Click the radio button- Access multiple bytes.
 - Key in the slave device address in the Slave address field.
 - Key in the register offset in the Register Offset field.
 - Key in the desired number of bytes, such as 3, in the right side field of radio button- Access multiple bytes. The number must be written in decimal.
 - Click the READ SMBus DATA button and then all data from the device will be divided from each other by commas and be shown in the Result field.

 - Write Multiple bytes
 - Click the radio button- Access multiple bytes.
 - Key in the slave device address in the Slave address field.
 - Key in the register offset in the Register Offset field.
 - Key in the desired number of bytes, such as 3, in the right side field of the radio button- Access multiple bytes. The number must be written in decimal.
 - Key in all the desired data in the Result field in hexadecimal format, divided by commas, for example, 0x50,0x60,0x7A.
 - Click the WRITE SMBus DATA button and all of the data will be written to the device through the SMBus.

Display Control

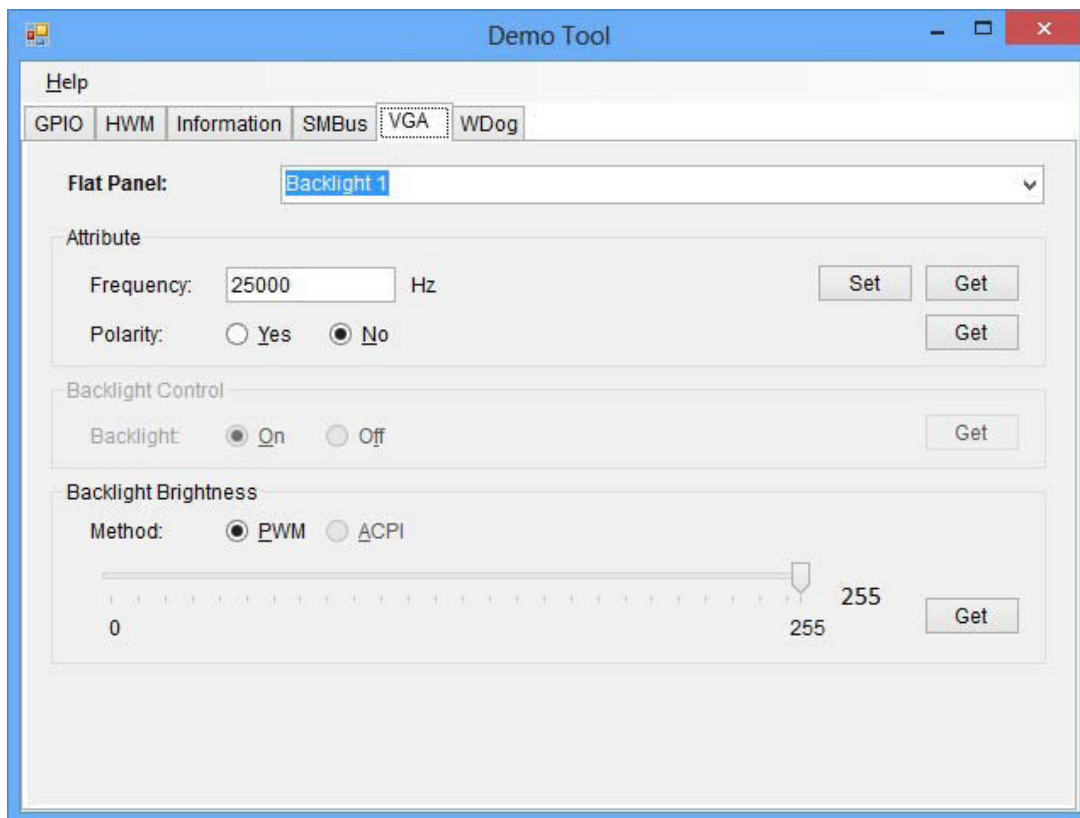

When the application is executed, it will display two blocks of VGA control functions. The application can turn on or turn off the screen shot freely, and it also can tune the brightness of the panels if your platform is being supported. You can test the functionality of VGA control as follows:

- Screen on/off control
 - Click the radio button ON or push the key F11 to turn on the panel screen.
 - Click the radio button OFF or push the key F12 to turn off the panel screen.
 - The display chip of your platform must be in the support list in Appendix A, or this function cannot work.
- Brightness control
 - Move the slider in increments, using either the mouse or the direction keys, or click the UP button to increase the brightness.
 - Move the slider in decrements, using either the mouse or the direction keys, or click the DOWN button to decrease the brightness.

Watchdog

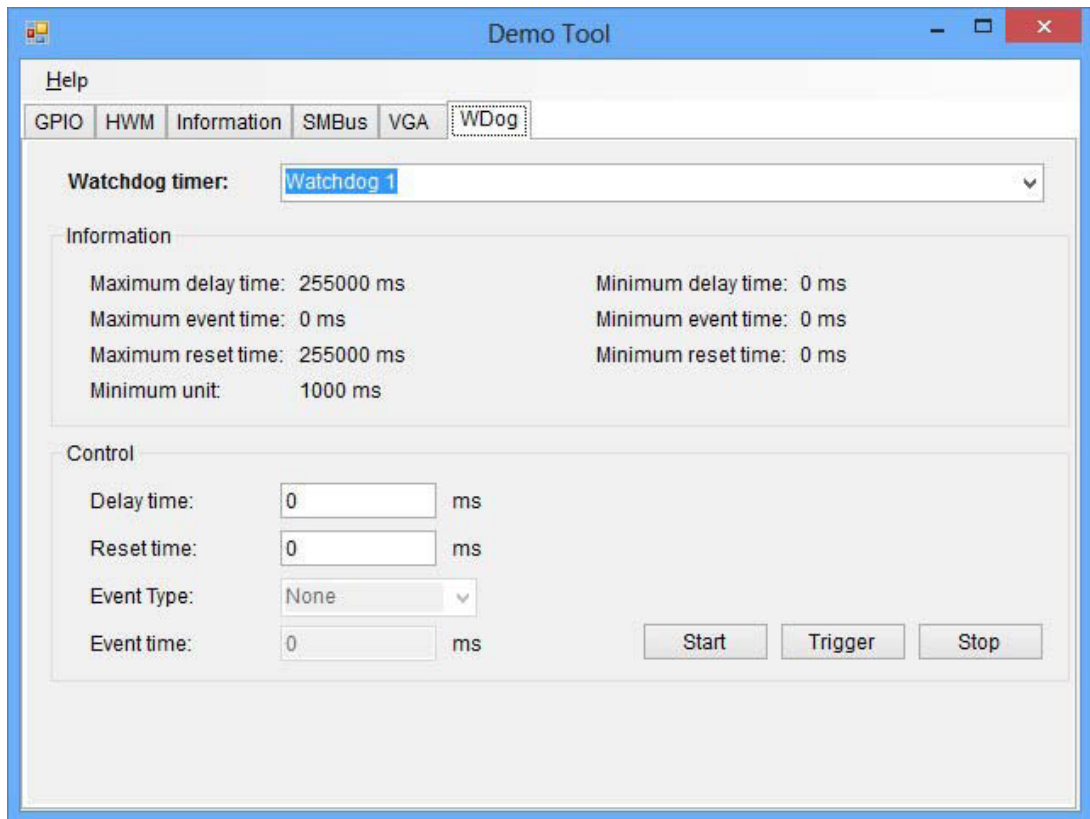

When the application is executed, it will display watchdog information in the WATCHDOG INFORMATION group box. It displays max timeout, min timeout, and timeout steps in milliseconds. For example, a 1~255 seconds watchdog will have 255000 max timeout, 1000 min timeout, and 1000 timeout steps. You can test the functionality of the watchdog as follows:

- Set the timeout value 3000 (3 sec.) in the SET TIMEOUT field and set the delay value 2000 (2 sec.) in the SET DELAY field, then click the START button. The Timeout Countdown field will countdown the watchdog timer and display 5000 (5 sec.).
- Before the timer counts down to zero, you can reset the timer by clicking the REFRESH button. After you click this button, the Timeout Countdown field will display the value of the SET TIMEOUT field.
- If you want to stop the watchdog timer, just click the STOP button.

Hardware Monitor

The screenshot shows a window titled "Demo Tool" with a menu bar containing "Help" and a tabbed interface with "GPIO", "HWM", "Information", "SMBus", "VGA", and "Wdog". The "HWM" tab is active, displaying a table of hardware monitoring data.

Item Name	Value	Minimum Value	Maximum Value	Unit
Voltage				
Vcore	0.789	0.789	0.796	V
5V	4.765	4.739	4.791	V
12V	11.75	11.75	11.812	V
CMOS Battery	3.02	3.007	3.033	V
Temperature				
CPU	40	39	40	Celsius
System	41	40	41	Celsius

When the Monitor application is executed by clicking the button, hardware monitoring data values will be displayed. If certain data values are not supported by the platform, the correspondent data field will be grayed-out with a value of 0.

For more details on MIO-2263 software API, please contact your dealer or Advantech AE.

Appendix **A**

PIN Assignments

A.1 Jumper Setting

Table A.1: Jumper List

J1	LCD Power / Auto Power on
----	---------------------------

A.2 Connectors

Table A.2: Connectors

CN1	12 V Power Input
CN2	DC JACK (by request)
CN3	12 V Power Input (2 x 3 pin support by request)
CN6	DDR3L SO-DIMM
CN9	GPIO
CN11	VGA
CN12	HDMI
CN13	Front Panel
CN14	SATA
CN15	mSATA
CN16	Mini PCIe
CN18	Internal USB
CN19	External USB 3.0 + USB 2.0
CN20	COM1/COM2
CN24	Gigabit Ethernet
CN27	HD Audio
CN29	MIOe
CN30	Inverter Power/Internal SATA Power
CN31	18/24 bits LVDS Panel
CN33	SMBus
BH1	Battery

Table A.3: J1: LCD Power/Auto Power On

Part Number	1653003260
Footprint	HD_3x2P_79
Description	PIN HEADER 3*2P 180D(M) 2.0mm SMD SQUARE PIN
Setting	Function
(1-2)	+5 V
(3-4) (default)	+3.3 V
(5-6) (default)	Auto Power On

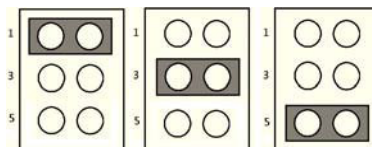

CN1	12 V Power Input
Part Number	1655003962
Footprint	WF_2P_156_D_A3963WV2
Description	
Pin	Pin Name
1	GND
2	+12 V

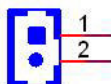

CN2	DC JACK (by request)
Part Number	1652005684
Footprint	PJ_3P_DCJ-RPBT5NW-25
Description	
Pin	Pin Name
1	+VIN
2	GND

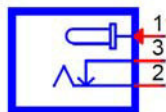

CN3	12V Power Input (2 x 3 pin support by request)
Part Number	1655000025
Footprint	WF_3x2P_79_BOX_D
Description	
Pin	Pin Name
1	GND
2	+12V
3	GND
4	+12V
5	GND
6	+12V

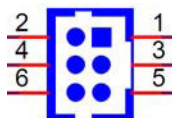

CN6	DDR3L SO-DIMM
Part Number	1651002083
Footprint	DDR3_204P_AS0A626-JA
Description	
Pin	Pin Name

CN9	GPIO
Part Number	1653005261
Footprint	HD_5x2P_79
Description	PIN HEADER SMD 5*2P 180D(M) 2.0 mm
Pin	Pin Name
1	+5 V
2	GPIO4
3	GPIO0
4	GPIO5
5	GPIO1
6	GPIO6
7	GPIO2
8	GPIO7
9	GPIO3
10	GND

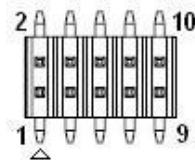

CN11	VGA
Part Number	1654000055
Footprint	DBVGA-VF5MS
Description	D-SUB Conn. 15P 90D(F) DIP 070242FR015S200ZU
Pin	Pin Name
1	RED
2	GREEN
3	BLUE
4	NC
5	GND
6	GND
7	GND
8	GND
9	NC
10	GND
11	NC
12	DDAT
13	HSYNC
14	VSYNC
15	DCLK

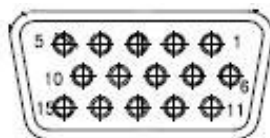

CN12	HDMI
Part Number	1654011175-01
Footprint	HDMI_19P_QJ51191-LFB4-7F
Description	
Pin	Pin Name
1	HMDP_TX0+
2	GND
3	HMDP_TX0-
4	HMDP_TX1+
5	GND
6	HMDP_TX1-
7	HMDP_TX2+
8	GND
9	HMDP_TX2-
10	HMDP_TX3+
11	GND
12	HMDP_TX3-
13	N/A
14	N/A
15	HMDP_DCLK
16	HMDP_DDAT
17	GND
18	+5V Power
19	Hot Plug Detect

CN13	Front Panel
Part Number	1653004883
Footprint	HD_3x2P_79_RA_21N22050
Description	
Pin	Pin Name
1	Power Button Pin1
2	Power LED+
3	Power/Reset Button Pin2
4	HDD LED+
5	Reset Button Pin1
6	HDD LED-

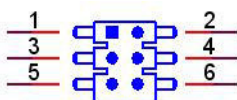

CN14	SATA
Part Number	1654011616-01
Footprint	SATA_7P_WATF-07DBN6SB1U
Description	
Pin	Pin Name
1	GND
2	TX+
3	TX-
4	GND
5	RX-
6	RX+
7	GND

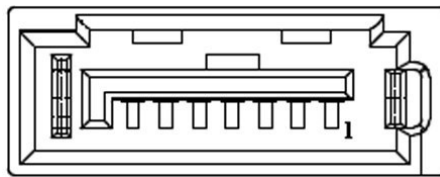

CN15	mSATA
Part Number	1654002538
Footprint	MINIPCIE_HALF_PICO_ITX
Description	
Pin	Pin Name
1	NC
2	+3.3V
3	NC
4	GND
5	NC
6	+1.5V
7	NC
8	NC
9	GND
10	NC
11	NC
12	NC
13	NC
14	NC
15	GND
16	NC
17	NC
18	GND
19	NC
20	NC
21	GND
22	NC

23	B+
24	+3.3V
25	B-
26	GND

CN15	mSATA
Part Number	1654002538
Footprint	MINIPCIE_HALF_PICO_ITX
Description	
Pin	Pin Name
27	GND
28	+1.5V
29	GND
30	SMB_CLK
31	A-
32	SMB_DAT
33	A+
34	GND
35	GND
36	NC
37	GND
38	NC
39	+3.3V
40	GND
41	+3.3V
42	NC
43	NC
44	NC
45	NC
46	NC
47	NC
48	+1.5V
49	NC
50	GND
51	NC
52	+3.3V

CN16	Mini PCIe
Part Number	1654002538
Footprint	MINIPCIE_HALF_PICO2600
Description	
Pin	Pin Name
1	WAKE#
2	+3.3VSB
3	NC
4	GND
5	NC
6	+1.5V
7	NC
8	NC
9	GND
10	NC
11	REFCLK-
12	NC
13	REFCLK+
14	NC
15	GND
16	NC
17	NC
18	GND
19	NC
20	NC
21	GND
22	PERST#
23	PERn0
24	+3.3VSB
25	PERp0
26	GND

CN16	Mini PCIE
Part Number	1654002538
Footprint	MINIPCIE_HALF_PICO2600
Description	
Pin	Pin Name
27	GND
28	+1.5 V
29	GND
30	SMB_CLK
31	PETn0
32	SMB_DAT
33	PETp0
34	GND
35	GND
36	USB D-
37	GND
38	USB D+
39	+3.3 VSB
40	GND
41	+3.3 VSB
42	NC
43	GND
44	NC
45	NC
46	NC
47	NC
48	+1.5 V
49	NC
50	GND
51	NC
52	+3.3 VSB

CN18	Internal USB
Part Number	1653005260
Footprint	HD_5x2P_79_N10
Description	PIN HEADER 2*5P 180D(M) 2.0 mm SMD IDIOT-PROOF
Pin	Pin Name
1	+5 V
2	+5 V
3	A_D-
4	B_D-
5	A_D+
6	B_D+
7	GND
8	GND
9	GND

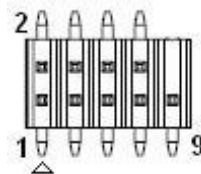

CN19	External USB2.0+USB3.0
Part Number	1654010199
Footprint	USB_13P_UEA1112C-UHS6-4F
Description	
Pin	Pin Name
1	+5V
2	D-
3	D+
4	GND
5	SSRX-
6	SSRX+
7	GND
8	SSTX-
9	SSTX+
10	+5V
11	D-
12	D+
13	GND

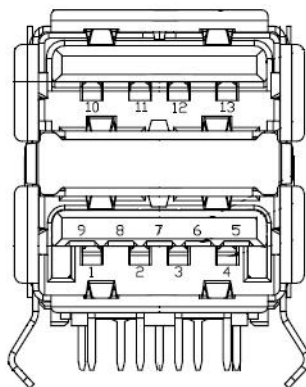

CN20	COM1/COM2
Part Number	1653003720
Footprint	HD_10x2P_79_RA
Description	
Pin	Pin Name
1	DCD1#
2	DSR1#
3	RXD1
4	RTS1#
5	TXD1
6	CTS1#
7	DTR1#
8	RI1#
9	GND
10	GND
11	DCD2#
12	DSR2#
13	RXD2
14	RTS2#
15	TXD2
16	CTS2#
17	DTR2#
18	RI2#
19	GND
20	GND

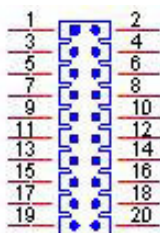

CN24	Gigabit Ethernet
Part Number	1652004356
Footprint	RJ45_14P_RT7-194AAM1A
Description	
Pin	Pin Name
1	BI_DA+(GHz)
2	BI_DA-(GHz)
3	BI_DB+(GHz)
4	BI_DC+(GHz)
5	BI_DC-(GHz)
6	BI_DB-(GHz)
7	BI_DD+(GHz)
8	BI_DD-(GHz)
H3	GND
H4	GND

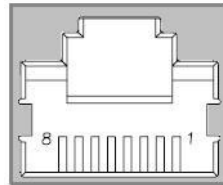

CN27	HD Audio
Part Number	1653003719
Footprint	HD_5x2P_79_RA_21N22050
Description	
Pin	Pin Name
1	LOUTR
2	LINR
3	GND
4	GND
5	LOUTL
6	LINL
7	GND
8	GND
9	MIC1R
10	MIC1L

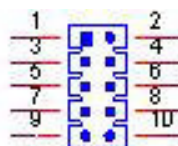

CN29	MIOe
Part Number	1654006235
Footprint	BB_40x2P_32_1625x285_2HOLD
Description	
Pin	Pin Name
1	GND
2	GND
3	PCIE_RX0+
4	PCIE_TX0+
5	PCIE_RX0-
6	PCIE_TX0-
7	GND
8	GND
9	PCIE_RX1+
10	PCIE_TX1+
11	PCIE_RX1-
12	PCIE_TX1-
13	GND
14	GND
15	NC
16	NC
17	NC
18	NC
19	GND
20	GND
21	NC
22	NC
23	NC
24	NC
25	GND
26	GND

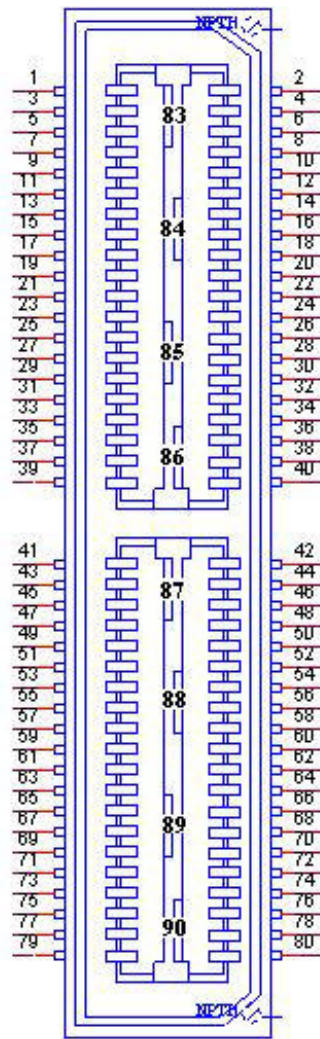

CN29		MIOe	
Part Number	1654006235		
Footprint	BB_40x2P_32_1625x285_2HOLD		
Description			
Pin	Pin Name		
27	PCIE_CLK+		
28	LOUTL		
29	PCIE_CLK-		
30	LOUTR		
31	GND		
32	AGND		
33	SMB_CLK		
34	SCI#		
35	SMB_DAT		
36	NC		
37	PCIE_WAKE#		
38	NC		
39	RESET#		
40	NC		
41	SLP_S3#		
42	CLK33M		
43	NC		
44	LPC_AD0		
45	DDP_HPDP		
46	LPC_AD1		
47	GND		
48	LPC_AD2		
49	DDP_AUX+		
50	LPC_AD3		
51	DDP_AUX-		
52	LPC_DRQ#0		

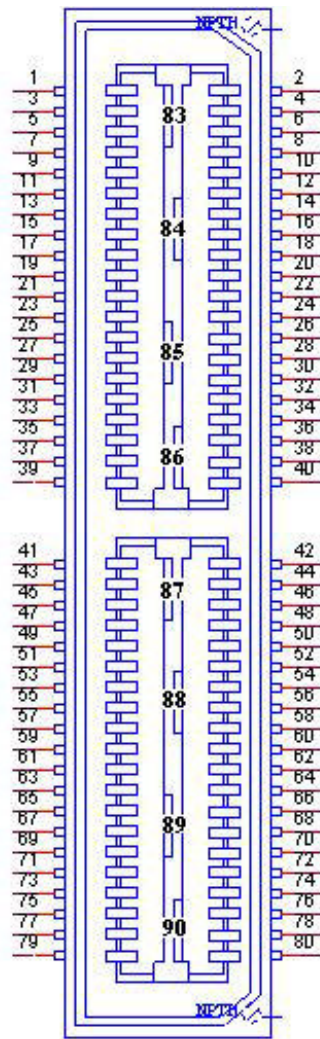

CN29	MIOe
Part Number	1654006235
Footprint	BB_40x2P_32_1625x285_2HOLD
Description	
Pin	Pin Name
53	GND
54	LPC_SERIRQ
55	DDP_D0+
56	LPC_FRAME#
57	DDP_D0-
58	GND
59	GND
60	USB0_D+
61	DDP_D1+
62	USB0_D-
63	DDP_D1-
64	GND
65	GND
66	USB1_D+/USB_SSTX+
67	DDP_D2+
68	USB1_D-/USB_SSTX-
69	DDP_D2-
70	GND
71	GND
72	NC
73	DDP_D3+
74	NC
75	DDP_D3-
76	GND
77	GND
78	USB_OC#

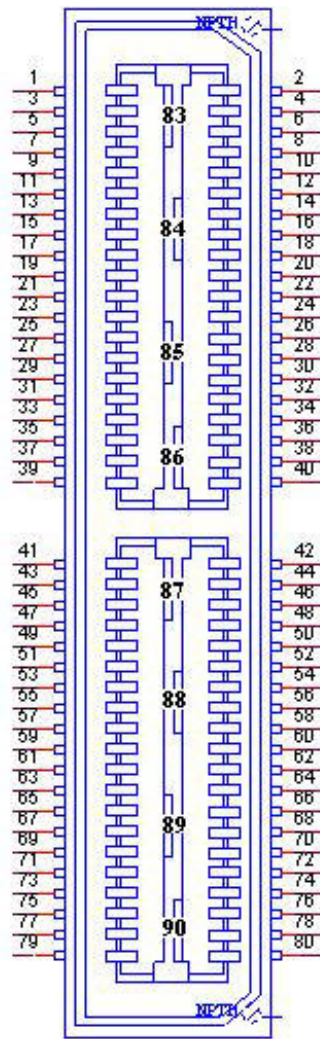

CN29	MIOe
Part Number	1654006235
Footprint	BB_40x2P_32_1625x285_2HOLD
Description	
Pin	Pin Name
79	+12VSB
80	+12VSB
83	GND
84	GND
85	GND
86	GND
87	+5VSB
88	+5VSB
89	+5VSB
90	+5VSB

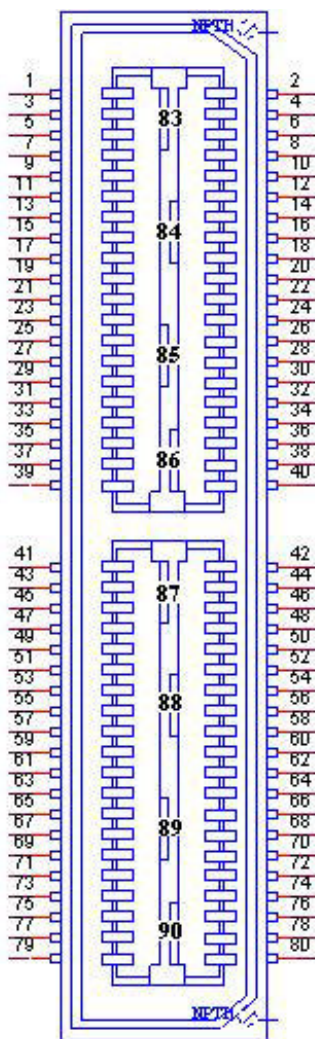

CN30	Inverter Power/ Internal SATA Power
Part Number	1655905100
Footprint	WF_5P_49_BOX_RA
Description	Wafer 1.25mm 5P 90D Male SMD 852040
Pin	Pin Name
1	+12V
2	GND
3	ENABKL
4	VBR
5	+5V

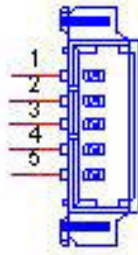

CN31	18/24 bits LVDS Panel
Part Number	1655000753
Footprint	WF14P_49_BOX_RA_85204-14001
Description	
Pin	Pin Name
1	GND
2	GND
3	LVDS0_CLK-
4	LVDS0_CLK+
5	LVDS0_D3-
6	LVDS0_D3+
7	LVDS0_D2-
8	LVDS0_D2+
9	LVDS0_D1-
10	LVDS0_D1+
11	LVDS0_D0-
12	LVDS0_D0+
13	+5 V or +3.3 V
14	+5 V or +3.3 V

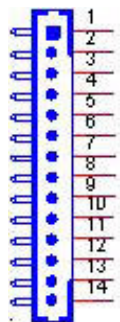

CN33	SMBus
Part Number	1655904020
Footprint	FPC4V-125M
Description	Wafer SMT 1.25 mm S/T type 4P 180D(M) 85205-04001
Pin	Pin Name
1	GND
2	SMB_DAT
3	SMB_CLK
4	+5 V

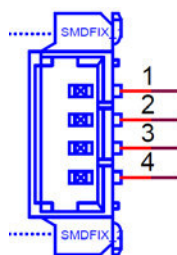

Appendix **B**

WDT & GPIO

B.1 Watchdog Timer Sample Code

Watchdog function:

The SCH3114 Runtime base I/O address is A00h
Setting WatchDog time value location at offset 66h
If set value "0", it is mean disable WatchDog function.

```
Superio_GPIO_Port = A00h
mov dx,Superio_GPIO_Port + 66h
mov al,00h
out dx,al
.model small
.486p
.stack 256
.data
SCH3114_IO EQU A00h
.code
org 100h
.STARTup
;=====
;47H
;enable WDT function bit [0]=0Ch
;=====
mov dx,SCH3114_IO + 47h
mov al,0Ch
out dx,al
;=====
;65H
;bit [1:0]=Reserved
;bit [6:2]Reserve=00000
;bit [7] WDT time-out Value Units Select
;Minutes=0 (default) Seconds=1
;=====
mov dx,SCH3114_IO + 65h;
mov al,080h
out dx,al
;=====
;66H
;WDT timer time-out value
;bit[7:0]=0~255
;=====
mov dx,SCH3114_IO + 66h
mov al,01h
out dx,al
;=====
;bit[0] status bit R/W
;WD timeout occurred =1;WD timer counting = 0
```

```

;=====
mov dx,SCH3114_IO + 68h
mov al,01h
out dx,al
.exit
END

```

B.2 GPIO Sample Code

The SCH3114 Runtime base I/O address is A00h

```

.model small
.486p
.stack 256
.data
SCH3114_IO EQU A00h
.code
org 100h
.STARTup
;=====
; Configuration GPIO as GPI or GPO by below register:
; GPIO0 = 23H, GPIO4 = 27H
; GPIO1 = 24H, GPIO5 = 29H
; GPIO2 = 25H, GPIO6 = 2AH
; GPIO3 = 26H, GPIO7 = 2BH
; Set 00H as output type, set 01H as input type
;=====
;=====
; Register 4BH configuration GPO value as high or low:
; 1 = HIGH
; 0 = LOW
;=====
mov dx,SCH3114_IO + 23h      ;GPIO 0
mov al,00h                  ;Set GPIO 0 as output type
out dx,al
mov dx,SCH3114_IO + 4Bh
mov al,01h                  ;Set GPIO 0 as high value.
out dx,al
.exit
END

```

Appendix **C**

System Assignments

C.1 System I/O Ports

Table C.1: System I/O Ports

Addr. Range (Hex)	Device
20-2D	Interrupt Controller
2E - 2F	Motherboard resources
30 - 3D	Interrupt Controller
40 - 43	System timer
4E - 4F	Motherboard resources
50 - 53	System timer
61 - 67	Motherboard resources
70 - 7F	System CMOS/real time clock
80 - 92	Motherboard resources
A0 - B1	Interrupt Controller
B2 - B3	Motherboard resources
B4 - BD	Interrupt Controller
2F8 - 2FF	COM2
3B0 - 3DF	Intel? HD Graphics
3F8 - 3FF	COM1
400 - 47F	Motherboard resources
4D0 - 4D1	Interrupt Controller
500-57F	Motherboard resources

C.2 1st MB Memory Map

Table C.2: 1st MB Memory Map

Addr. Range (Hex)	Device
A0000h - BFFFFh	IntelQ® HD Graphics
A0000h - BFFFFh	PCI Bus
C0000h - DFFFFh	PCI Bus
E0000h - FFFFFh	PCI Bus
90400000 - 905FFFFFF	Intel® Trusted Execution Engine Interface
E0000000 - FEFFFFFF	System resources

C.3 Interrupt Assignments

Table C.3: Interrupt assignments

Interrupt#	Interrupt Source
NMI	Parity error detected
IRQ0	System timer
IRQ1	Using SERIRQ, Keyboard Emulation
IRQ2	Slave controller INTR output
IRQ3	Communications Port (COM2)
IRQ4	Communications Port (COM1)
IRQ5	Available
IRQ6	Available
IRQ7	Available
IRQ8	Internal RTC or HPET
IRQ9	Microsoft ACPI-Compliant System
IRQ10	Available
IRQ11	SMBus Port
IRQ12	Available
IRQ13	Numeric data processor
IRQ14	SATA controller
IRQ15	SATA controller

ADVANTECH

Enabling an Intelligent Planet

www.advantech.com

Please verify specifications before quoting. This guide is intended for reference purposes only.

All product specifications are subject to change without notice.

No part of this publication may be reproduced in any form or by any means, electronic, photocopying, recording or otherwise, without prior written permission of the publisher.

All brand and product names are trademarks or registered trademarks of their respective companies.

© Advantech Co., Ltd. 2014

Our company network supports you worldwide with offices in Germany, Austria, Switzerland, the UK and the USA. For more information please contact:

Headquarters

Germany



FORTEC Elektronik AG

Augsburger Str. 2b
82110 Germering

Phone: +49 89 894450-0
E-Mail: info@fortecaq.de
Internet: www.fortecaq.de

Fortec Group Members

Austria



Distec GmbH Office Vienna

Nuschinggasse 12
1230 Wien

Phone: +43 1 8673492-0
E-Mail: info@distec.de
Internet: www.distec.de

Germany



Distec GmbH

Augsburger Str. 2b
82110 Germering

Phone: +49 89 894363-0
E-Mail: info@distec.de
Internet: www.distec.de

Switzerland



ALTRAC AG

Bahnhofstraße 3
5436 Würenlos

Phone: +41 44 7446111
E-Mail: info@altrac.ch
Internet: www.altrac.ch

United Kingdom



Display Technology Ltd.

Osprey House, 1 Osprey Court
Hichingbrooke Business Park
Huntingdon, Cambridgeshire, PE29 6FN

Phone: +44 1480 411600
E-Mail: info@displaytechnology.co.uk
Internet: www.displaytechnology.co.uk

USA



Apollo Display Technologies, Corp.

87 Raynor Avenue,
Unit 1 Ronkonkoma,
NY 11779

Phone: +1 631 5804360
E-Mail: info@apolloDisplays.com
Internet: www.apolloDisplays.com