



DATA DISPLAY GROUP

---

# Datasheet

**DMC Co., Ltd.**

**Projected Capacitive Touch Screen**

**DUS series Reference**

The information contained in this document has been carefully researched and is, to the best of our knowledge, accurate. However, we assume no liability for any product failures or damages, immediate or consequential, resulting from the use of the information provided herein. Our products are not intended for use in systems in which failures of product could result in personal injury. All trademarks mentioned herein are property of their respective owners. All specifications are subject to change without notice.

---

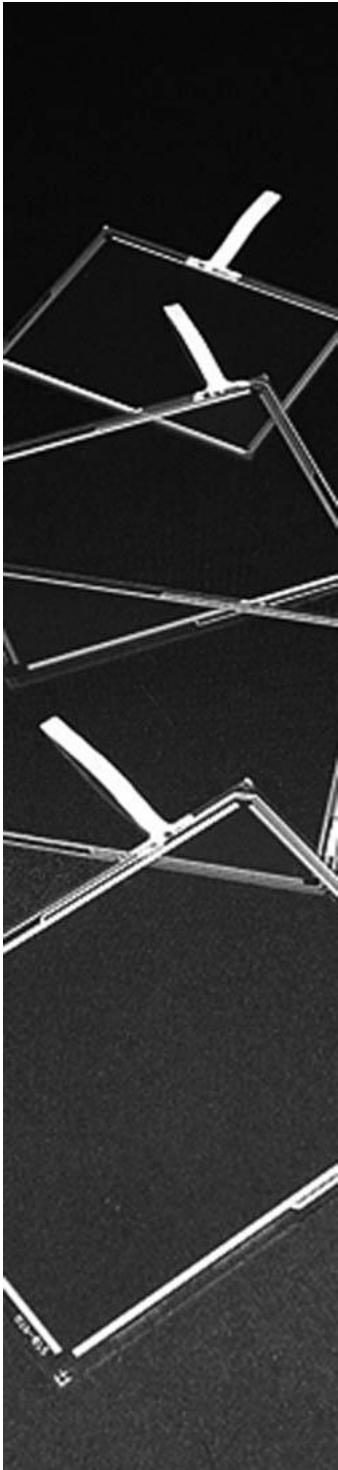

**DMC Co., Ltd.**

**Projected Capacitive Touchscreen  
DUS series Reference**

**Table of Contents**

<b>1. Product Specifications</b> .....	<b>2</b>
1-1. Product Applicable.....	2
1-2. Structure .....	2
1-3. Environmental Specifications.....	2
1-4. Mechanical Characteristics .....	2
1-5. Electrical Characteristics.....	2
<b>2. Testing Conditions</b> .....	<b>3</b>
2-1. Testing Conditions .....	3
2-2. Environmental Specifications.....	3
2-3. Mechanical Characteristics .....	3
2-4. Appearance.....	3
<b>3. Reliability Condition</b> .....	<b>4</b>
3-1. Temperature Condition.....	4
<b>4. Handling Notes</b> .....	<b>5</b>
4-1. Precautions .....	5
4-2. Handling Notes.....	5
4-3. Construction Notes .....	5
4-4. Electrical & Software Notice .....	5
4-5. Mounting Notes .....	6
<b>5. Warranty</b> .....	<b>9</b>
5-1. Warranty Period.....	9
5-2. Warranty Target .....	9
5-3. Warranty Exceptions.....	9
5-4. Tools .....	9
5-5. Changes .....	9
<b>6. Revision history</b> .....	<b>10</b>

**Visual Inspection Criteria**

Up to 22" Size

Exceed 22" Size

## 1. Product Specifications

### 1-1. Product Applicable

§ This specification is applied to the Projected Capacitive DUS series.

### 1-2. Structure

§ For Dimensional and structural information, refer to the attached drawing.

### 1-3. Environmental Specifications

Specification	Value
Operating Temperature	-20°C to 70°C (no condensation)
Operating Humidity	-20°C to 60°C Less than 90%RH (no condensation) Exceeding 60°C Less than 133.8g/m <sup>3</sup> (no condensation)
Storage Temperature	-40°C to 75°C (no condensation)
Storage Humidity	-40°C to 60°C Less than 95%RH (no condensation) Exceeding 60°C Less than 142.9g/m <sup>3</sup> (no condensation)
Chemical Resistance (top surface)	Toluene, Trichloroethylene, Acetone, Alcohol, Gasoline, Machine Oil, Ammonia, Glass Cleaner, Mayonnaise, Ketchup, Wine, Salad Oil, Vinegar, Lipstick, etc.

### 1-4. Mechanical Characteristics

Specification	Value
Operating Life	Input (finger) 50,000,000 hits
Light Transmittance	91% (typical value at full wavelength)
Surface Hardness	Over 5H (by JIS pencil hardness)
Electrode Matrix Pitch	Approximately 5-7mm

### 1-5. Electrical Characteristics

Specification	Value
Maximum Voltage	DC6V
Recommended touch contact area	>=PHI 10mm

## 2. Testing Conditions

### 2-1. Testing Conditions

§ If the condition is not specified, the test is performed under the supplier's standard testing condition.

§ Tests are performed under the room temperature unless specified. The room temperature is regarded as follows:

Temperature: 20°C±5°C

Humidity: 65%±10%RH

### 2-2. Environmental Specifications

§ Chemical Resistance Test

Condition: Tested after leaving the chemical on the surface for 12 hours then wiping it off by cloth.

Judgement: Must be no effect in appearance.

### 2-3. Mechanical Characteristics

§ Operating Life Test

Condition: Testing rod: Refer to Figure 1

Load: 3N

Cycle: 2 hits/sec

Judgement: Must operate properly after the test

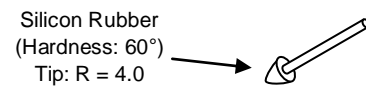

Figure 1. Testing rod 1

### 2-4. Appearance

§ Appearance Test

Condition: Tested by an examiner with over 1.0 eyesight at 30cm away from the product under the transmittable light at angle of over 60° to surface of the product.

Judgement: Must satisfy the specification.

### **3. Reliability Condition**

#### **3-1. Temperature Condition**

##### § Temperature Condition Test

Following test are performed in the condition with no dew condensation:

**Cold Test:** Tested after leaving the parts in  $-40^{\circ}\text{C}\pm 3^{\circ}\text{C}$  for 240 hours and in the room temperature for 2 hours.

**Heat Test:** Tested after leaving the parts in  $75^{\circ}\text{C}\pm 3^{\circ}\text{C}$  for 240 hours and in the room temperature for 2 hours.

**Humidity Test:** Tested after leaving the parts in the temperature  $60^{\circ}\text{C}\pm 3^{\circ}\text{C}$ , humidity 90 to 95% for 240 hours and in the room temperature for 2 hours.

**Cycle Test:** Tested after 5 cycles of leaving the parts in the temperature  $-30^{\circ}\text{C}\pm 3^{\circ}\text{C}$  for 1 hour and in the room temperature for 0.5 hours, then leaving the parts in the temperature  $70^{\circ}\text{C}\pm 3^{\circ}\text{C}$  for 1 hour and in the room temperature for 0.5 hours.

**Judgement:** Must satisfy the following:

Function : Operate properly.

Appearance: Must satisfy the specification.

## **4. Handling Notes**

### **4-1. Precautions**

§ This product is intended for use in standard applications (computers, office automation, and other office equipment, industrial, communications, and measurement equipment, personal and household devices, etc.) Please avoid using this product for special applications where failure or abnormal operation may directly affect human lives, or cause physical injury or property damage, or where extremely high levels of reliability are required (such as aerospace systems, vehicle operating control, atomic energy controls, medical devices for life support, etc.).

### **4-2. Handling Notes**

§ Do not press or scratch the product with any object with a sharp edge or end.

§ Do not forcibly bend or fold the product.

§ When the product is stored, make sure it is packed in a packing box and stored in a storage temperature range, eliminating any outside load.

§ Do not use or store the product under a condition where the product will be exposed to water, organic solution or acid.

§ Do not use the product under the direct sunlight if a film material is used on it.

§ Do not disassemble the product.

§ When you handle the product, hold the product by its body. Do not hold by the tail.

§ Clean the product with a soft cloth or a soft cloth with neutral detergent or alcohol. When contaminated with chemicals, wipe them off immediately with caution not to cause injury to human body.

§ The edge of the glass is not rounded and may cause injury.

### **4-3. Construction Notes**

§ The environmental specifications, mechanical characteristics, and electrical characteristics are only applied to the Active Area.

§ Do not use the touchscreen when the condensation occurs. The condensation inside of the touchscreen is a natural phenomenon and should disappear after the touchscreen is warmed up.

### **4-4. Electrical & Software Notice**

Projected Capacitive Touchscreen was designed to work with our controller board.

If the driver software is to be developed by the customer, please study the characteristics of touch screen and controller before development.

**4-5. Mounting Notes**

Projected capacitive touchscreen detects the touched locations by measuring the increased amount of the capacitance value between its electrodes at inputs. Once it is built into a system, capacitance couplings are continually yielded among the touchscreen, FPC tail, controller board and metal Chassis. When turned on, our projected capacitive touchscreen will automatically adjust its sensitivity level to the surrounding environment at the standby state in order to avoid the affects by the surrounding capacitance couplings. If surrounding environment changes or materials to alter the electrical field (a large capacitor, power-supply unit, LCD panel, or materials with high dielectric constant) is near, these external factors will adversely affect the function of the touch screen to detect the correct input positions.

At structure design, please refer to the mounting notes below and ensure enough gap distances among each component in order to avoid the external factors described above.

4-5-1. Mounting

Fix the touchscreen firmly so that the gap distances between the touchscreen and other components will not be affected by touching or will not change with the passage of time. An unexpected input may be caused if the gap is too narrow.

The locations on which a certain gap distance is required are as follows.

- Between LCD panel and touchscreen: L1
- Between touchscreen and the surface of the bezel: L4
- Between touchscreen and the back of the bezel: L2
- Between tail and LCD panel, tail and metal chassis : L3 & L5 (an insulating tape can be used)

In case of using capacitive sensor outside, the moisture may cause the trouble.

4-5-1-1. Mounting Touchscreen on a display

It is recommended to use an insulating resin material for the bezel. Ensure the gap between the touchscreen and front bezel (L4)

If a metal plate is used for the bezel, unintended capacitance couplings may occur on the periphery of the active area. If a metal material is used for bezel, ensure the gap of approximately 2mm between touchscreen and bezel (L2).

In order to avoid the gap distance L1 from being changed with the passage of time, it is recommended to apply the adhesive tape onto all the 4 sides with no space (fully sealed) when gluing the touch screen.

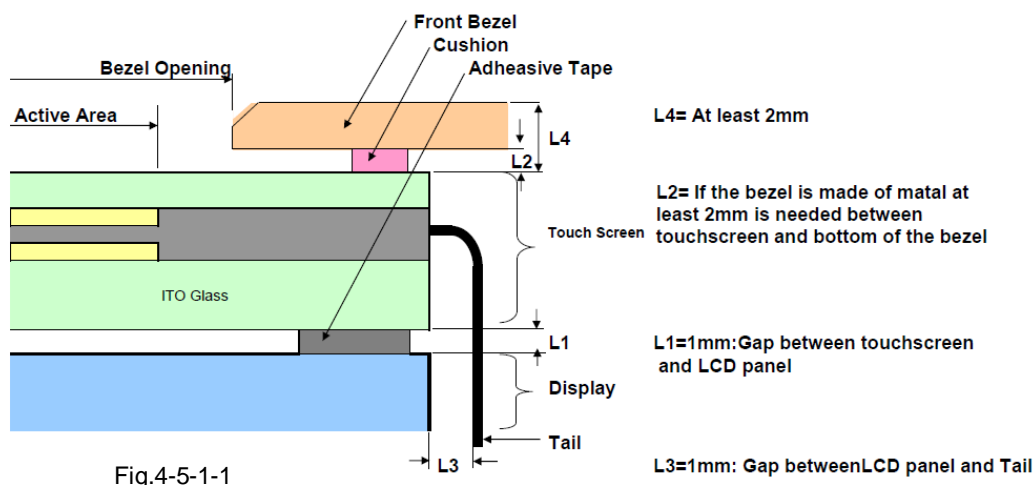

Fig.4-5-1-1



4-5-1-2. Mounting touchscreen on back side of the bezel

It is recommended to use an insulating resin material for the bezel. Ensure the gap between the touchscreen and front bezel (L4).

If a metal plate is used for the bezel, unintended capacitance couplings may occur on the periphery of the active area.

If a metal plate or any other metallic materials is used for the bezel, ensure the gap distance of approximately 2mm between the touchscreen and bezel (L2).

Fix the touchscreen firmly so that the gap distance L1 will not be affected.

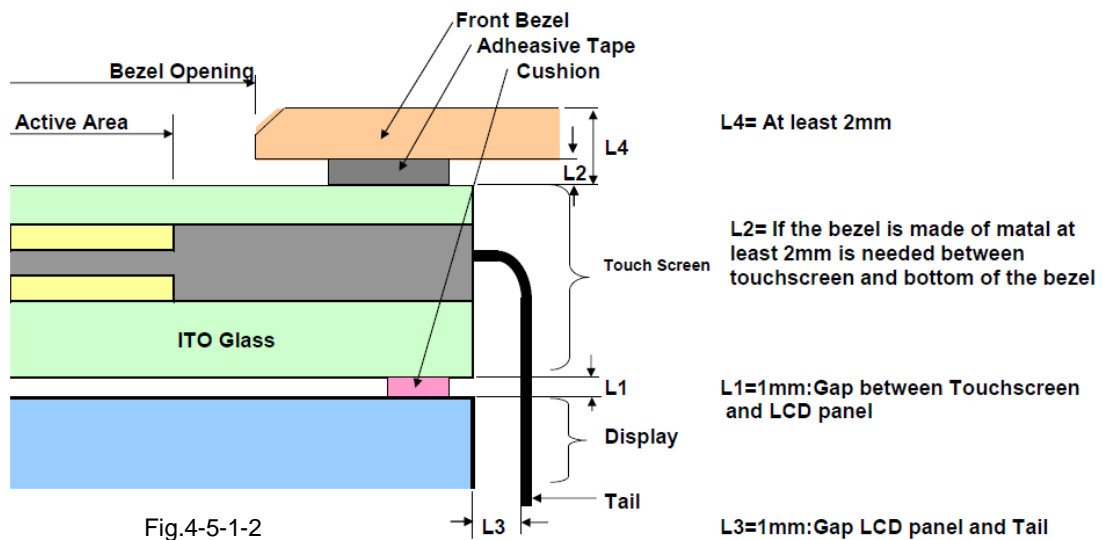

Fig.4-5-1-2

4-5-1-3. Flat Surface Design

If the Flat Surface Design is preferred, please consult with us before proceeding. Thickness of cover glass and capacitance couplings at the periphery of the touchscreen must be considered for each individual case.

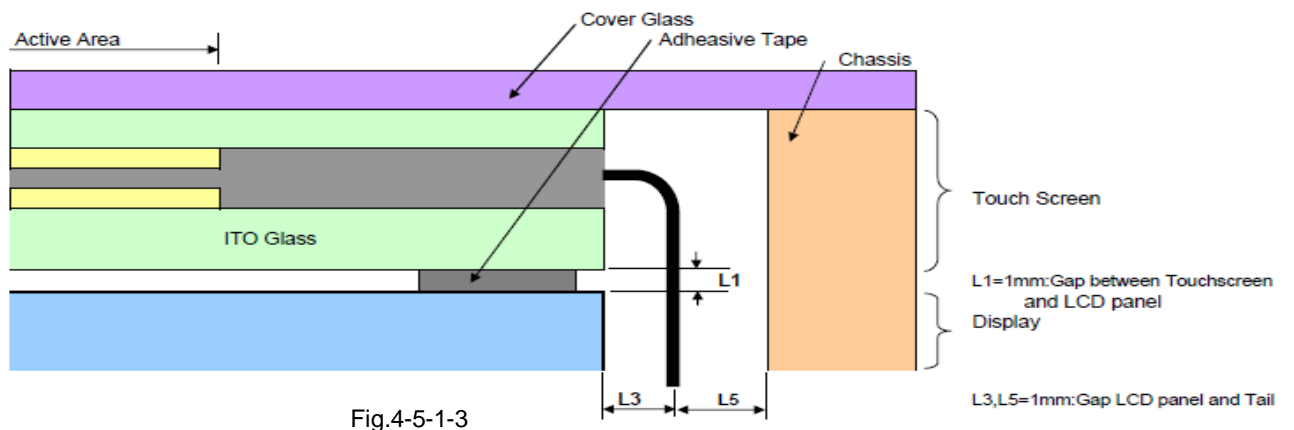

Fig.4-5-1-3

#### 4-5-2 Tolerance

There is a tolerance of 0.2 to 0.3mm for the dimensions of the touchscreen and tail. A gap must be made in the case and the connector to absorb the tolerance.

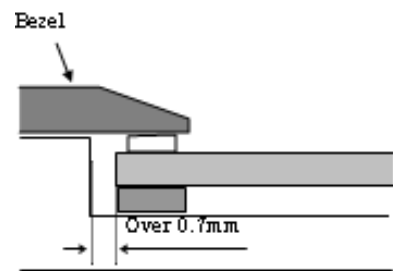

Fig.4-5-2

#### 4-5-3.Tail

The tail must not be forcibly stressed or bent too hard. The conduction in the insulated area and wire breaking may be caused

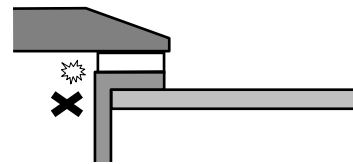

Fig.4-5-3

## **5. Warranty**

### **5-1. Warranty Period**

- § The warranty period is limited to 1 year from the date of shipment. The warranty for the initial defects such as appearance deflection is limited to 1 month.
- § Any defected parts under proper use will be examined by the supplier and replaced by the new parts if the defect is considered to be caused by the supplier.
- § The replacement is subject to be included in the next lot.

### **5-2. Warranty Target**

- § The warranty only covers the product itself and does not cover any damage to others caused by using this product. Onsite repair or replacement is not supported.
- § We will do our best for delivery problem and product defect, but the warranty for the production line is not covered.
- § Capacitive touchscreens are structurally not repairable. All defected parts are subject to replacement.

### **5-3. Warranty Exceptions**

Following conditions are not covered with the warranty and subject to charge.

- § Any malfunctions and damages during transportation and transfer by the user.
- § Any malfunctions and damages caused by a natural disaster or a fire.
- § Any malfunctions and damages caused by static electricity
- § Any malfunctions and damages caused by the failure of the associated equipment.
- § If the product is remodeled, disassembled or repaired by the user.
- § If the product is glued onto the equipment and uninstalled.
- § Any malfunctions and damages caused by an improper usage and handling against the specifications and notes.

### **5-4. Tools**

- § To maintain the quality, the printing screens and the die-cut plates are generally limited to use up to 1 year. Reorders after 1 year from the initial order or from the last renewal are subject to the tooling charge for replacing the printing screens and the die-cut plates. Reorders for the discontinued standard parts are also subject to tooling charge.
- § All the tools, such as CAD data (except for the drawing for approval), block copies (films), printing screens, and die-cut plates are not to be provided due to administrative reason.

### **5-5. Changes**

- § Because of the manufacturing process, changing the dimensions, circuit pattern, and the tail position requires replacing most of the tools and is subject to high tooling charge. Please be careful when ordering and approving the drawing.
- § Circuit pattern and the materials that does not affect the environmental, electrical, and mechanical characteristics such as film, glass, ink and glue are subject to change for the supplier's reason or for improvement within the specifications.
- § Standard products are subject to change for improvement without notice.

## 6. Revision history

Rev 1.0(October 01, 2012)

Initial release

Rev 1.1 (January 01, 2013)

Visual Inspection Criteria was added as a separate document.

Projected Capacitive Touchscreen DUS series Reference

Rev. 1.1, January 30, 2013

©2013 DMC Co., Ltd.

This document can be freely distributed, but any alternation to this document is prohibited.

**DMC Co., Ltd.**

<http://www.dmccoltd.com/english/>

11F Nisseki Takanawa Bldg., 2-18-10 Takanawa, Minato-ku, Tokyo 108-0074, Japan

Phone: +81-3-6721-6731 (Japanese), 6736 (English) Fax: +81-3-6721-6732

<b>Visual Inspection Criteria</b>	Type	Pro-Cap
	Part No	Standard Model (Up to 22" Size)
	File No	@069i

1. Appearance Criteria (for viewing area with and without cover glass)

Item	W: Width W(mm)	L: Length(mm)	Acceptable Number	Total
Liner (Foreign substance/scratch/ transparent defects) Defects over 0.15mm in diameter will be judged in circular. Transparent defects mean bubble. * e.g.:1 lint etc...	$0.15 \geq W > 0.1$	$5 \geq L$	Up to 1pc per product	<b>【22" <math>\geq</math> Size &gt; 14"】</b> Up to 10 defects per product  <b>【14" <math>\geq</math> Size &gt; 10"】</b> Up to 7 defects per product  <b>【10" <math>\geq</math> Size】</b> Up to 5 defects per product
	$0.1 \geq W > 0.08$	$15 \geq L$	Up to 1 defect in $\phi 25\text{mm}$ including other kinds of defects	
	$0.08 \geq W$	$20 \geq L$	Acceptable	
Circular (Foreign substance/scratch/ transparent defects) Transparent defects mean bubble, lint *1, etc...	$0.7 \geq D > 0.5$		Up to 1 defect per product	<b>【10" <math>\geq</math> Size】</b> Up to 5 defects per product
	$0.5 \geq D > 0.3$		Up to 1 defect in $\phi 25\text{mm}$ including other kinds of defects	
	$0.3 \geq D$		Acceptable	
	D: average diameter = (longest + shortest diameters) / 2			
Dirt	No easily noticeable and no clear outline dirt should be OK			

\*1 Lint is the defect that is different transparent from other part due to the elevating surface by printing over foreign substance.

2. Chip (touch screen)

Site	Chips at areas other than electrode sections					
Judgment Criteria (for all sizes)	<p>Chip at Corner</p>			<p>Chip other than at corners</p>		
	X	Y	Z	X	Y	Z
	$0.5 \leq X \cdot Y \leq 2.0(\text{mm})$			$\leq t$	$\leq 5.0(\text{mm})$	$0.5 \leq Y \leq 2.0(\text{mm})$
Acceptable Numbers	Up to 2 defects per product			Up to 8 defects per product, but each defects must be 20mm away from each other at each side.		
	X·Y<0.5mm is acceptable But, if the chip reaches to Ag pattern, it is unacceptable.			Y<0.5mm is acceptable But, if the chip reaches to Ag pattern, it is unacceptable.		

3. progressive Crack

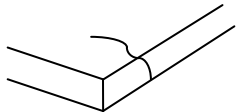
Defect illustration	Judgment
	NG

4. Appearance criteria for color-printed area of covering glass (judged from surface view)

Item	Defect contents	Acceptable range	
Color Tone	Different color tone from original color	Color Sample etc.	
Color Peeling	Color print coming off	Unacceptable	
Color Lacking	Color print partly missing	Unacceptable	
Color Running	Ink bleed	The defect should not be over edge face	
Scratch	Scratch on color-printed part	Base glass should not be exposed	
Color Unevenness	Color thickness is uneven	Should be no color unevenness that can be easily detected. (should not be detectable by gaze for 4 – 6 seconds)	
Pinhole through to the base glass, Adhering foreign substance which is different color from the printing	D: average diameter = (longest + shortest diameters) / 2	Acceptable quantity	Total acceptable quantity
	$0.3 \geq D > 0.2$ $0.2 \geq D$	Up to 2 defects in $\phi 30\text{mm}$ Acceptable	Up to 5 defects per product
Tilt/Misalignment	—	Should be within tolerances indicated by the drawing	

5. Chips and cracks on covering glass

Item	Defect contents	Acceptable range
Crack	Progressive crack, chip: Refer to section 3	Unacceptable
Chip	Chip (non-progressive crack) : Refer to section 2	Shorter than 3mm in length and narrower than 0.5mm in width: less than 5 defects. The defect should not be recognizable from the glass surface. Within $Y < 0.2\text{mm}$ is acceptable. But the chip should not be over the printing.

<b>Visual Inspection Criteria</b>	Type	Pro-Cap
	Part No	Standard Model (Exceed 22" Size)
	File No	@083b

1. Appearance Criteria (for viewing area with and without cover glass)

Item	W: Width W(mm)	L: Length(mm)	Acceptable Number	Total
Liner (Foreign substance/scratch/ transparent defects) Defects over 0.15mm in diameter will be judged in circular. Transparent defects mean bubble. * e.g.:1 lint etc...	$0.15 \geq W > 0.1$	$5 \geq L$	Up to 2pc per product	Up to 15 defects per product
	$0.1 \geq W > 0.08$	$15 \geq L$	Up to 1 defect in $\phi 25\text{mm}$ including other kinds of defects	
	$0.08 \geq W$	Acceptable	Acceptable	
$1.0 \geq D > 0.7$		Up to 2 defect per product		
Circular (Foreign substance/scratch/ transparent defects) Transparent defects mean bubble, lint *1, etc...	$0.7 \geq D > 0.3$		Up to 1 defect in $\phi 25\text{mm}$ including other kinds of defects	Up to 15 defects per product
	$0.3 \geq D$		Acceptable	
	D: average diameter = (longest + shortest diameters) / 2			
Dirt	No easily noticeable and no clear outline dirt should be OK			

\*1 Lint is the defect that is different transparent from other part due to the elevating surface by printing over foreign substance.

2. Chip (touch screen)

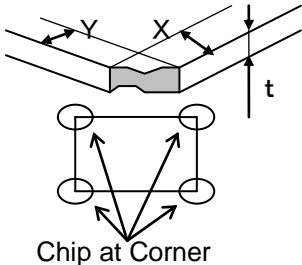
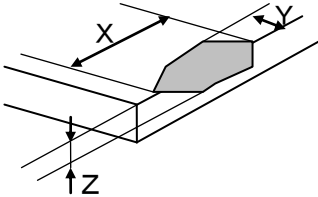
Site	Chips at areas other than electrode sections					
Judgment Criteria (for all sizes)	 <p style="text-align: center;">Chip at Corner</p>			 <p style="text-align: center;">Chip other than at corners</p>		
	X	Y	Z	X	Y	Z
	$0.5 \leq X \cdot Y \leq 2.0(\text{mm})$			$\leq t$	$\leq 5.0(\text{mm})$	$0.5 \leq Y \leq 2.0(\text{mm})$
Acceptable Numbers	Up to 2 defects per product			Up to 15 defects per product, but each defects must be 20mm away from each other at each side.		
	X·Y<0.5mm is acceptable But, if the chip reaches to Ag pattern, it is unacceptable.			Y<0.5mm is acceptable But, if the chip reaches to Ag pattern, it is unacceptable.		

3. progressive Crack

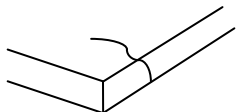
Defect illustration	Judgment
	NG

4. Appearance criteria for color-printed area of covering glass (judged from surface view)

Item	Defect contents	Acceptable range	
Color Tone	Different color tone from original color	Color Sample etc.	
Color Peeling	Color print coming off	Unacceptable	
Color Lacking	Color print partly missing	Unacceptable	
Color Running	Ink bleed	The defect should not be over edge face	
Scratch	Scratch on color-printed part	Base glass should not be exposed	
Color Unevenness	Color thickness is uneven	Should be no color unevenness that can be easily detected. (should not be detectable by gaze for 4 – 6 seconds)	
Pinhole through to the base glass, Adhering foreign substance which is different color from the printing	D: average diameter = (longest + shortest diameters) / 2	Acceptable quantity	Total acceptable quantity
	$0.3 \geq D > 0.2$  $0.2 \geq D$	Up to 2 defects in $\phi 30\text{mm}$  Acceptable	Up to 5 defects in $\phi 30\text{mm}$
Tilt/Misalignment	–	Should be within tolerances indicated by the drawing	

5. Chips and cracks on covering glass

Item	Defect contents	Acceptable range
Crack	Progressive crack, chip: Refer to section 3	Unacceptable
Chip	Chip (non-progressive crack) : Refer to section 2	Shorter than 3mm in length and narrower than 0.5mm in width: less than 5 defects. The defect should not be recognizable from the glass surface. Within $Y < 0.2\text{mm}$ is acceptable. But the chip should not be over the printing.



Our company network supports you worldwide with offices in Germany, Great Britain, Italy, Turkey and the USA. For more information please contact:



---

## DATA DISPLAY GROUP

**Distec GmbH**

Augsburger Str. 2b  
82110 Germering  
Germany

Phone: +49 (0)89 / 89 43 63-0  
Fax: +49 (0)89 / 89 43 63-131  
E-Mail: [info@datadisplay-group.de](mailto:info@datadisplay-group.de)  
Internet: [www.datadisplay-group.de](http://www.datadisplay-group.de)

**Display Technology Ltd.**

5 The Oaks Business Village  
Revenge Road, Lordswood  
Chatham, Kent, ME5 8LF  
United Kingdom

Phone: +44 (0)1634 / 67 27 55  
Fax: +44 (0)1634 / 67 27 54  
E-Mail: [info@datadisplay-group.co.uk](mailto:info@datadisplay-group.co.uk)  
Internet: [www.datadisplay-group.co.uk](http://www.datadisplay-group.co.uk)

**Apollo Display Technologies, Corp.**

87 Raynor Avenue, Unit 1 Ronkonkoma, NY  
11779

United States of America

Phone: +1 631 / 580-43 60  
Fax: +1 631 / 580-43 70  
E-Mail: [info@datadisplay-group.com](mailto:info@datadisplay-group.com)  
Internet: [www.datadisplay-group.com](http://www.datadisplay-group.com)

**Sales Partner:****REM Italy s.a.s.**

di Michieletto Flavio & C.  
Via Obbia Bassa, 10  
I-35010 Trebaseleghe (PD)  
Italy  
Phone: +39 335 521 37 89  
E-Mail: [info@remitaly.com](mailto:info@remitaly.com)  
Internet: [www.remitaly.com](http://www.remitaly.com)

**Sales Partner:****DATA DISPLAY BİLİŞİM TEKNOLOJİLERİ  
İÇ VE DIŞ TİCARET LİMİTED ŞİRKETİ**

Barbaros Mh Ak Zamabak Sk A Blok  
D:143 Ataşehir/İstanbul  
Turkey  
Phone: +90 (0)216 / 688 04 68  
Fax: +90 (0)216 / 688 04 69  
E-Mail: [info@data-display.com.tr](mailto:info@data-display.com.tr)  
Internet: [www.data-display.com.tr](http://www.data-display.com.tr)